

**MAHLE**

*Driven by performance*

# ENGINE COMPONENTS AND FILTERS: DAMAGE PROFILES, PROBABLE CAUSES AND PREVENTION

Technical Information

AFTERMARKET



# Contents

<b>1</b>	<b>Introduction</b>	5
<b>2</b>	<b>General topics</b>	6
2.1	Engine wear caused by contamination	6
2.2	Fuel flooding	8
2.3	Hydraulic lock	10
2.4	Increased oil consumption	12
<b>3</b>	<b>Top of the piston and piston ring belt</b>	14
3.1	Hole burned through the top of the piston in gasoline and diesel engines	14
3.2	Melting at the top of the piston and the top land of a gasoline engine	16
3.3	Melting at the top of the piston and the top land of a diesel engine	18
3.4	Broken piston ring lands	20
3.5	Valve impacts at the top of the piston and piston hammering at the cylinder head	22
3.6	Cracks in the top of the piston	24
<b>4</b>	<b>Piston skirt</b>	26
4.1	Piston seizure on the thrust and opposite side (piston skirt area only)	26
4.2	Piston seizure on one side of the piston skirt	27
4.3	Diagonal piston seizure next to the pin bore	28
4.4	Asymmetrical wear pattern on the piston skirt	30
4.5	Piston seizure in the lower piston skirt area only	31
4.6	Heavy wear at the piston skirt with a rough, matte surface	32
4.7	Wear marks on one side of the piston skirt	33
<b>5</b>	<b>Support – piston pin bushing</b>	34
5.1	Seizure in the pin bore	34
5.2	Cratered piston wall in the pin boss area	35
<b>6</b>	<b>Piston rings</b>	36
6.1	Piston rings with burn marks and seizure marks on the piston skirt	36
6.2	Damage to the ring belt due to fractured piston rings	37
6.3	Heavy wear of the piston ring grooves and piston rings	38
6.4	Heavy radial wear of the piston rings	39
<b>7</b>	<b>Cylinder liners</b>	40
7.1	Pitting on the outer wall of cylinder liners (cavitation)	40
7.2	Snapped off flange of cylinder liners	42
7.3	Longitudinal cracks in cylinder liners	44

<b>8</b>	<b>Valves</b>	45
8.1	Valve stem scuffing	45
8.2	Distortion at the valve stem	46
8.3	Fracture in the valve groove	47
8.4	Fracture in the valve head area	48
8.5	Valve seat wear	49
8.6	Deformation of the valve head	50
8.7	Hole burned through the valve head	51
<b>9</b>	<b>Bearings</b>	52
9.1	Scoring and contamination at the running surface of bearings	52
9.2	Localized wear marks on the running surface of bearings	53
9.3	Heavy wear marks in the area of the parting line of bearings	54
9.4	Shiny marks, wear or corrosion on the outer surface of bearings	55
9.5	Abrasion or damage to the outer edges of bearings	56
9.6	Heavy wear at all main bearings	57
9.7	Uneven wear pattern at the bearings	58
9.8	Seizure marks at the bearings	59
9.9	Pitting on the bearing layer of the bearings	60
9.10	Porous bearing layer of the bearings	61
<b>10</b>	<b>Filters</b>	62
10.1	Filter leakage	62
10.2	Reduced engine performance due to the filter	64
10.3	Assembly problems with filters	65
10.4	Granules escaping from air dryer cartridges	66
10.5	Disintegrated filters	67
<b>11</b>	<b>Glossary</b>	68



# 1 Introduction

MAHLE is a leading development partner and supplier of engine components and systems as well as filters for the automotive industry. In close cooperation with engine and vehicle manufactures, MAHLE engineers develop high-quality products worldwide. The same high-quality guidelines also apply to spare parts for the aftermarket.

Numerous checks during and after production guarantee the highest quality of MAHLE products. If problems occur during operation, they can usually be attributed to the engine, e.g. incorrect ignition setting, mixture preparation or the electronic control unit. Operating or assembly errors as well as inadequate lubrication and fuels are some of the main breakdown causes.

This brochure summarizes typical types of damage. It describes their probable causes and provides information on how to prevent such damage in the future. This should facilitate the search for the possible cause of damage. This information ensures the extensive and reliable functioning of our products and a corresponding long service life for engines.

Furthermore, our experts are also confronted with complex damage processes which cannot be explained in this brochure due to space limitations. However, in the event that damage occurs to our products, we will be more than willing to examine them at our facility and to write an expert damage report for you. Please contact your local sales partner or MAHLE representative.

## 2 General topics

### 2.1 Engine wear caused by contamination

#### DESCRIPTION

Engine wear caused by contamination is usually indicated by increased oil consumption. The examination of returned components shows various types of damage:

- The piston skirt displays a scuffing, wide wear pattern on the thrust and opposite side (Fig. 1).
- The machining profile at the piston skirt (Fig. 2) and at the contact surfaces (cylinder wall or cylinder liner) has been removed (Fig. 3).
- The piston skirt, piston rings, cylinder wall and/or cylinder liner display fine scoring marks in the running direction.
- The piston rings and groove walls are heavily worn (Fig. 4).
- There is a large end gap at the piston rings. The edges of the rings are razor sharp.
- The faces of the oil control ring are worn (Fig. 5).
- The piston pin shows longitudinal scoring marks with a wavelike profile (Fig. 6).
- Wear caused by contamination can also be found on other components, for example at a valve stem (Fig. 7).

#### PROBABLE CAUSES

Several types of wear caused by contamination can be distinguished depending on the number of damaged cylinders and the amount of the piston ring wear:

##### If only one cylinder is damaged ...

**... and the top ring is more worn than the oil control ring,** contamination has reached the combustion chamber via the intake system of one cylinder, i.e. from above. This is caused either by a leak or debris which was not removed prior to assembly.

##### If several or all of the cylinders are damaged ...

**... and the top ring is more worn than the oil control ring,** contamination has reached the combustion chamber via the common intake system of all the cylinders. This is either due to leaks and/or a defective or missing air filter.

**... and the oil control ring is more worn than the top ring,** contaminated engine oil is the culprit. The oil is contaminated either due to an uncleaned crankcase and/or a dirty oil mist separator.

#### REMEDY/PREVENTION

- Check the intake system for leaks.
- Check the air filter and, if necessary, replace it.
- Clean the crankcase and the intake manifolds prior to assembly.
- Always pay attention to cleanliness during assembly.



Fig. 1  
Wear caused by contamination at the piston – longitudinal scoring marks



Fig. 2  
Partially removed machining profile at the piston skirt



Fig. 3  
Worn cylinder liner



Fig. 4  
Axial wear at the piston rings

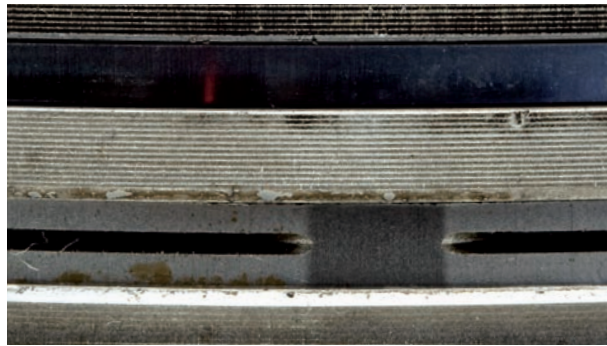

Fig. 5  
Heavily worn oil control ring



Fig. 6  
Worn piston pin



Fig. 7  
Heavily worn valve stem

## 2.2 Fuel flooding

### DESCRIPTION

- The wear pattern is wide, shiny and shows deep scoring marks along the entire piston skirt (*Fig. 1*).
- Scoring marks on the piston rings, possibly additional burn marks on the piston ring surface (*Fig. 2*).
- The honing in the cylinder liner or cylinder running surface is heavily worn (*Fig. 3*).
- Heavy wear marks are visible at the piston pin. Pitting visible in the pin bore (*Fig. 4a+b*).

### PROBABLE CAUSES

An excessive amount of fuel in the oil dilutes the oil film, thus drastically reducing its load-bearing ability and increasing engine component wear. This type of damage can have the following causes:

- The injection system is set incorrectly.
- Cold start enrichment is too rich.
- The injection nozzles are functioning incorrectly, e.g. due to a clogged fuel filter.
- Due to an excessive protrusion, the piston hammers the cylinder head, causing uncontrolled injection.
- The compression is weak. This can be attributed to the following conditions:
  - A valve is leaky.
  - The cylinder head gasket is leaky.
  - The timing is set incorrectly.
  - The protrusion is too small.
  - One piston ring or several piston rings are defective.
  - An error has occurred in the ignition system, e.g. a defective spark plug.

### REMEDY/PREVENTION

- Set the injection system correctly (cold start enrichment, etc.).
- Check the injection nozzles.
- Installation dimensions must be observed.
- Always adhere to fuel filter maintenance intervals, and shorten the time between intervals accordingly in extreme conditions.
- Check the spark plugs and, if necessary, replace them.

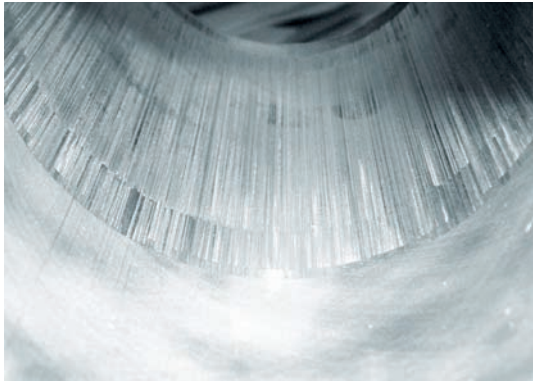

*Fig. 1*  
Wide wear pattern and scoring marks due to fuel dilution





*Fig. 2*  
*Scoring marks and burn marks on the piston rings*



*Fig. 3*  
*Scoring and seizure marks in the cylinder bore*



*Fig. 4a*  
*Pitting in the pin bore due to diluted engine oil*



*Fig.4b*  
*Even more visible when magnified: the pitting*

## 2.3 Hydraulic lock

### DESCRIPTION

Hydraulic lock generates enormous forces. This can have an effect on numerous components:

- The piston is broken or deformed (*Fig. 1*).
- The connecting rod is bent or broken (*Fig. 2*).
- The piston ring land of the piston concerned shows an overload fracture (*Fig. 3a+b*).
- The piston pin is broken.

### PROBABLE CAUSES

This damage is caused by liquid. Water or fuel reaching the combustion chamber. Since neither water nor fuel can be compressed, hydraulic lock results in an abrupt stress load at the piston, the piston pin, the connecting rod, the cylinder head, the crankcase, the bearing and the crankshaft. Excessive liquid may reach the combustion chamber due to the following reasons:

- Water reaches the combustion chamber via the intake system (e.g. when driving through water).
- Cooling water enters the combustion chamber due to defective gaskets.
- Excessive fuel reaches the combustion chamber due to a defective injection nozzle.

### REMEDY/PREVENTION

- Always use new and undamaged gaskets when overhauling an engine. Defective gaskets must be replaced.
- Always check injection nozzles and, when necessary, renew them.



*Fig. 1*  
Broken commercial  
vehicle piston due to  
hydraulic lock



Fig. 2  
Bent and broken connecting rod due to hydraulic lock



Fig. 3a  
Overload fracture from the top of the piston to the pin bore



Fig. 3b  
Close-up view of an overload fracture

## 2.4 Increased oil consumption

### DESCRIPTION

A certain amount of oil consumption is normal. Oil consumption varies depending on the engine type and the stress load. If the level of oil consumption recommended by the manufacturer is exceeded, it is referred to as increased oil consumption – in contrast to oil loss caused, e.g., by a leak, etc.

### PROBABLE CAUSES

- Oil reaches the combustion chamber via the intake passage due to leaks in the turbocharger, e.g. worn bearings.
- The oil return pipe at the turbocharger is clogged or carbonized. Rising pressure in the oil circuit results in oil being pressed out of the turbocharger and into the intake passage and the exhaust gas system.
- Oil reaches the combustion chamber together with the fuel – e.g. due to a worn injection pump, which is usually lubricated via the oil circuit of the engine.
- Due to a leaky intake system, contamination has entered the combustion chamber, increasing wear (also see section “2.1 Engine wear caused by contamination”, page 6).
- The piston can hammer against the cylinder head due incorrect piston protrusion. The resulting vibrations affect the injection nozzle. Possible result: The nozzle no longer closes fully, resulting in excessive fuel reaching the combustion chamber and ultimately fuel flooding (also see section “2.2 Fuel flooding”, page 8).
- The oil is too old – e.g. due to irregular maintenance. This reduces the load-bearing ability, leading to increased wear.
- Irregular oil change intervals cause clogging and/or cracking of the filter paper, resulting in unfiltered engine oil running through the oil circuit.
- Bent or twisted connecting rods mean that the piston no longer travels in a straight line and the combustion chamber is insufficiently sealed (also see section “4.4 Asymmetrical wear pattern on the piston skirt”, page 30). In the worst case scenario, the piston may act as a pump. Oil is then actively transported into the combustion chamber.
- If the piston rings are broken, wedged or installed incorrectly, it may result in inadequate sealing between the combustion chamber and the crankcase. Oil can reach the combustion chamber via this leak.
- The cylinder head bolts have been tightened incorrectly. This may result in distortion and thus leaks in the oil circuit.
- The level of blow-by gases increases due to worn pistons, piston rings and cylinder bores. This results in excess pressure in the crankcase. Excess pressure can force oil mist into the combustion chamber via the crankcase ventilation.
- Due to an excessive amount of oil, the crankshaft is immersed in engine oil in the oil pan, resulting in oil mist. Furthermore, old or inferior oil can cause the formation of oil foam. The oil mist or oil foam then enters the intake passage and ultimately the combustion chamber together with the blow-by gases via the engine ventilation.



*Fig. 1  
Immediately turn off the ignition when  
this symbol appears!*

- An abnormal combustion can lead to fuel flooding. If oil is diluted with fuel, wear at the piston, piston rings and cylinder running surface increases dramatically (also see section “2.2 Fuel flooding”, page 8).
- Inferior oils often display less load-bearing ability and can therefore facilitate increased wear.
- The piston rings may no longer provide a tight seal between the combustion chamber and the crankcase due to cylinder distortion caused, e.g., by old and/or incorrectly tightened cylinder head bolts. In this case, oil mist can reach the combustion chamber. Extreme distortion can even cause the piston to act as a pump, i.e. oil is practically pumped into the combustion chamber.
- Inadequate machining of the cylinder with a poorly honed cylinder running surface prevents correct oil absorption. This leads to increased wear of the contact surfaces, such as the piston, the piston rings and the cylinder running surface, and ultimately to defective sealing of the crankcase. The graphite layer in the cylinder running surface is smeared if the honing stones are clogged. A so-called smeared metal layer develops. This considerably reduces the oil absorption capacity, and results in increased wear particularly during a cold start.
- When compressors are used for the air brake, a leaky valve plate can facilitate the formation of condensed water in the cylinder. This condensed water dilutes the lubricating oil, resulting in increased wear of pistons, piston rings and cylinder running surfaces. The oil also reaches the compressed air system and causes damage to other components (also see section “10.4 Granules escaping from air dryer cartridges”, page 66).



Fig. 2  
A smoky exhaust pipe

## 3 Top of the piston and piston ring belt

### 3.1 Hole burned through the top of the piston in gasoline and diesel engines

#### DESCRIPTION

- There is a hole in the top of the piston (*Fig. 1*).
- The surface surrounding the hole is coated with melted piston material.
- The top land has melted (*Fig. 2*).
- The top of the piston has melted and the piston ring belt has partially burned-through (*Fig. 3*).

#### PROBABLE CAUSES

The damage is caused by localized hot spots. However, it is important to differentiate between gasoline and diesel engines.

##### Gasoline engine:

- The heat value of the spark plug is too low.
- Surface ignitions caused by an overheated spark plug have occurred (also see section “3.2 Melting at the top of the piston and the top land in a gasoline engine”, page 16).

##### Diesel engine:

The piston crown has overheated, but the combustion bowl is not damaged. An excellent spray pattern can be observed at the top of the piston. The excessive temperature level at the top of the piston can be caused by the following:

- The cooling oil nozzle is either bent, has become detached or has not been assembled (assembly error).
- The time between oil changes is too long. In this case, there is a risk of polymerization of the engine oil, especially when using biofuels, such as rapeseed and soybean oil, which can result in the cooling oil nozzles being clogged.
- Contamination, such as gasket residue, etc., prevents the required circulation in the oil circuit.

*Fig. 1*  
Hole in the top of the piston, caused by the use of spark plugs with an incorrect heat value



## REMEDY/PREVENTION

### Gasoline engine:

- Only use fuel with the specified octane rating.
- Set the injection system, the carburetor and the ignition correctly.
- Only use spark plugs which correspond to the manufacturer's specifications.
- Check the intake system for leaks.

### Diesel engine:

- Set the injection amount and timing according to the manufacturer's specifications.
- Check the injection nozzles for any leaks, the injection pressure and the spray pattern.
- Pay attention to correct alignment when assembling the cooling oil nozzles.
- The time between oil changes must be much shorter when running the engine on biofuels.
- Thoroughly clean the oil channels in the engine block, the crankshaft and the cylinder head.
- Make sure the pressure regulating valve is functioning correctly.



Fig. 2  
Melted top land of a gasoline piston



Fig. 3  
Hole burned through a diesel piston

## 3.2 Melting at the top of the piston and the top land of a gasoline engine

### DESCRIPTION

The type of damage described here includes several stages, ranging from melting to a hole in the top of the piston:

- The surface is roughened and there is slight erosion on the edge of the top of the piston (*Fig. 1*).
- The piston ring land is broken (*Fig. 2a+b*).
- Melted areas can be seen at the piston crown (*Fig. 3*) – right up to a completely melted off top of the piston incl. piston ring land fracture. (*Fig. 4*).
- There is a hole in the piston.

### PROBABLE CAUSES

This damage can be attributed to an abnormal combustion. This can be influenced by a number of factors:

- Combustion is from a too lean air-fuel mixture, which may be caused by the following:
  - There is an intake of additional air.
  - There is an engine management problem, e.g. the fuel delivery.
  - The carburetor setting is incorrect.
  - A sensor is defective (mass air flow sensor, lambda probe, TDC sensor, etc).
- Incorrect fuel has been used (insufficient octane rating, diesel instead of gasoline).
- The heat value of the spark plug is too low.
- The ignition timing is set incorrectly.
- The charge-air pressure is too high (e.g. due to tuning).
- Individual components or the entire engine are overheated.  
This is caused, e.g., by:
  - Insufficient valve clearance, resulting in overheating of the valve head.
  - Excessive intake air temperature.
  - A fault in the coolant circuit, e.g. insufficient water, a loose V-belt or a defective thermostat.

### REMEDY/PREVENTION

- Only use fuel with the specified octane rating.
- Set the injection system, the carburetor and the ignition correctly.
- Only use spark plugs which correspond to the manufacturer's specifications.
- Check the intake system for leaks.
- Use a thicker gasket for a re-machined cylinder head, and ensure the compression height is less for oversize pistons.
- Pay attention to the correct charge-air pressure for a turbocharged engine.



*Fig. 1*  
Erosion at a gasoline piston





Fig. 2a  
Broken piston ring lands

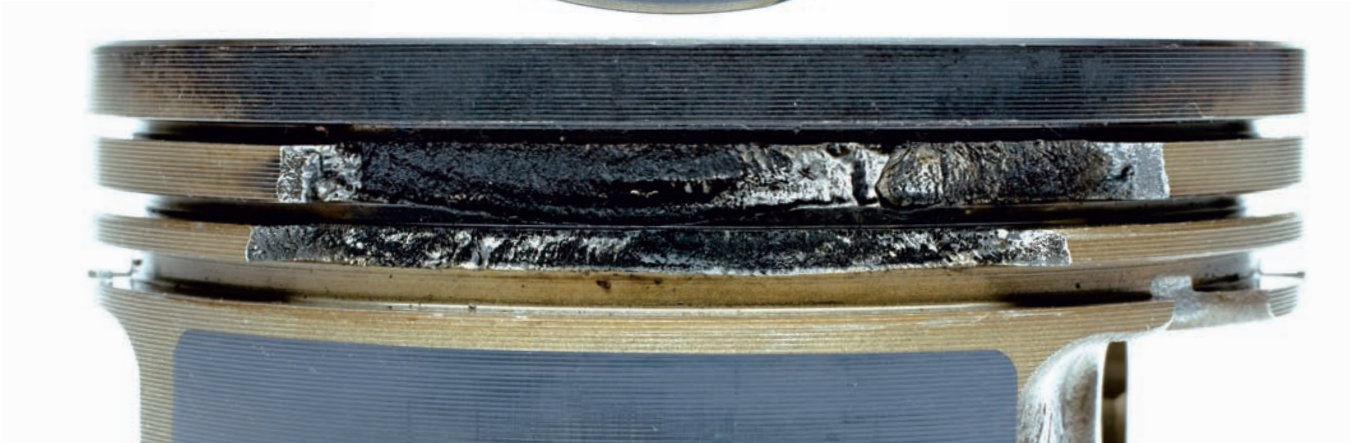

Fig. 2b  
Close-up view of the broken piston ring lands



Fig. 3  
Heavy erosion and melting at the piston crown



Fig. 4  
Hole melted through the piston ring belt of a gasoline piston

## 3.3 Melting at the top of the piston and the top land of a diesel engine

### DESCRIPTION

The damage described here includes several stages, ranging from light damage at the piston to catastrophic engine failure.

- Erosion at the piston crown is visible.
- Melted areas can be seen at the piston crown (*Fig. 1*) – right up to a completely melted off top of the piston (*Fig. 2*).
- In extreme cases, there are seizure marks all along and around the piston.
- There is a hole in the piston.

### PROBABLE CAUSES

This damage is attributed to the thermal overload of the piston. There are two causes for this:

#### Abnormal combustion:

This fault can be diagnosed via the following features:

- The bowl edge has been “gnawed off”.
- The injection nozzles display a poor spray pattern.
- The injection pressure and the delivery rate of the injection nozzles are set incorrectly.
- The top land shows seizure marks in the piston pin axis.

An abnormal combustion can be caused by a number of factors:

- The air-fuel mixture in the combustion chamber is too rich. This can be the result of the following:
  - The air supply is reduced, e.g. the air filter is clogged.
  - The fuel delivery is set incorrectly.
  - The start of fuel delivery is set incorrectly.
  - The nozzle needle is either wedged or stiff.
  - The exhaust gas system is clogged.
- There is ignition delay and misfiring which may be caused by the following:
  - The incorrect fuel or fuel with an insufficient cetane rating is being used, or there is gasoline in the diesel.
  - The valves are leaky, resulting in compression loss.
  - The protrusion is too small, i.e. there is insufficient compression.
  - The air pre-warming is defective (especially for very low ambient temperatures).



*Fig. 1*  
Melting at the top land of a diesel piston

### Overheating of the piston crown:

This can be identified via the following features:

- The combustion bowl is not damaged.
- An excellent spray pattern can be observed at the top of the piston.

The excessive temperature level of the piston crown can be caused by the following:

- The cooling oil nozzle is either bent, has become detached or has not been assembled (assembly error).
- The time between oil changes is too long. In this case, there is a risk of polymerization of the engine oil, especially when using biofuels, such as rapeseed and soybean oil, which can result in the cooling oil nozzles being clogged.
- Contamination, such as gasket residue, etc., prevents the required circulation in the oil circuit.

### REMEDY/PREVENTION

- Set the injection amount and timing according to the manufacturer's specifications.
- Check the injection nozzles for any leaks, the injection pressure and the spray pattern.
- Pay attention to correct alignment when assembling the cooling oil nozzles.
- Thoroughly clean the oil channels in the engine block, the crankshaft and the cylinder head.
- Make sure the pressure regulating valve is functioning correctly.
- Ensure that the time between oil changes is much shorter when running the engine on biofuels.



Fig. 2  
Melted piston crown at a diesel piston

## 3.4 Broken piston ring lands

### DESCRIPTION

- There are two types of fracture behavior for broken piston ring lands: from top to bottom (Fig. 1a+b) and from bottom to top (Fig. 2–3).
- There is erosion at the top of the piston, the top land and on the groove walls.

### PROBABLE CAUSES

These types of damage are caused by mechanical overload which results from an abnormal combustion, an assembly error or hydraulic lock.

#### 1. Abnormal combustion:

Once the ignition has been started via the ignition sparks, spontaneous ignition occurs at other areas of the combustion chamber, resulting in an approx. tenfold increase in the combustion speed. This leads to a steep increase in pressure of up to 300 bar per crank angle degree (default value 3–5 bar per crank angle degree) as well as to ultrasound-like vibrations and overheating due to irregular combustion behavior. The consequences are cracks or fractures to the piston ring lands and the piston skirt from top to bottom. This abnormal combustion is known as “knocking”.

Knocking combustion can be caused by the following:

#### Gasoline engine:

- The ignition timing is incorrect (pre-ignition).
- The air-fuel mixture is too lean.
- Fuel with an inadequate octane rating has been used.
- The intake air is too hot.
- The compression ratio is too great.

#### Diesel engine:

An excessive ignition delay results – as with knocking at the gasoline engine – in uncontrolled combustion with high pressure peaks and in mechanical overload of the piston ring lands. This can be attributed to:

- Insufficient compression pressure.
- Insufficient injection pressure of the nozzles.
- Incorrect use of starting aids, e.g. “ether” starting fluid.
- Leaky injection nozzles.
- An excessive amount of fuel being injected.

#### 2. Assembly error:

- If the piston rings have been installed without using a ring compressor, they are quite often not properly seated in the groove. During subsequent installation of the piston in the cylinder, the rings protrude fractionally, thus blocking the front of the bore. A typical bottom to top fracture of the piston ring lands occurs.
- With a two-stroke engine the fracture runs from top to bottom, as the piston is forced into the cylinder from the underside.



Fig. 1a  
Broken piston ring lands caused by an abnormal combustion



Fig. 1b  
Close-up view of the fracture behaviour from top to bottom

### 3. Hydraulic lock:

This damage is caused by liquid, water or fuel reaching the combustion chamber. Since neither water nor fuel can be compressed, hydraulic lock results in an abrupt stress load at the piston, the piston pin, the connecting rod, the cylinder head, the crankcase, the bearing and the crankshaft (also see section “2.3 Hydraulic lock”, page 10). Excessive liquid may reach the combustion chamber due to the following reasons:

- Water reaches the combustion chamber via the intake system (e.g. when driving through water).
- Coolant enters the combustion chamber due to defective gaskets.
- Excessive fuel reaches the combustion chamber due to a defective injection nozzle.

### REMEDY/PREVENTION

- Only use fuel with the specified octane rating.
- Set the injection system, the carburetor and the ignition correctly.
- Only use spark plugs which correspond to the manufacturer’s specifications.
- Check the intake system for leaks.
- Use a thicker gasket for a re-machined cylinder head, and ensure the compression height is less for oversize pistons.
- Pay attention to the correct charge-air pressure for a turbocharged engine.
- Always use new and undamaged gaskets when overhauling an engine, and do not forget to replace relevant gaskets.
- Always check injection nozzles and, when necessary, renew them.



Fig. 2  
Broken piston ring lands caused by an assembly error



Fig. 3  
Assembly error with an imprint of the piston ring

## 3.5 Valve impacts at the top of the piston and piston hammering at the cylinder head

### DESCRIPTION

- Valve impacts or contact marks are visible at the top of the piston due to collisions with the cylinder head (*Fig. 1–2*).
- The piston is snapped off at a right angle to the pin bore (*Fig. 3*) due to heavy hammering at the top of the piston.

### PROBABLE CAUSES

The type of damage described above is caused by a piston collision. Collision can occur with:

#### One or several valves:

The reasons for the collision may be:

- Due to over-speeding, the valve springs are unable to retract the valve in time and the piston collides with the valve/s.
- Due to an incorrect setting after engine installation or due to faulty chain tensioners, e.g. slack tensioner pulley, the timing is out.
- A valve is snapped off.
- The bearing clearance has become excessive due to spun connecting rod bearings or loose connecting rod bolts.
- After machining the cylinder head, the valve depths have not been checked and machined.

#### The cylinder head:

The reasons for the collision may be:

- The bearing clearance has become excessive due to worn connecting rod bearings or loose connecting rod bolts.
- With a diesel engine: Due to the excessive compression height of the piston or an insufficiently thick cylinder head gasket after grinding the cylinder head, the protrusion is too large (also see section “3.3 Melting at the top of the piston and the top land of a diesel engine”, page 18, and the engine-specific protrusion specifications in the online catalog).

#### Contamination:

The causes for contamination can be:

- Small components, e.g. bolts or nuts, have entered the combustion chamber during installation.
- Due to the oil consumption (also see section “2.4 Increased oil consumption”, page 12) and very short journeys, oil carbon has built up in the combustion chamber, thus increasing the protrusion.

All these causes of a collision can eventually lead to the piston being so badly damaged that it snaps off at a right angle to the pin bore (horizontal).

## REMEDY/PREVENTION

- Set the timing correctly during installation.
- Check the protrusion at all the cylinders during installation.
- If unusually loud operating noises are audible, switch off the ignition and determine the source of the noise to prevent any consequential damage.



Fig. 1  
Top of the piston with valve impact



Fig. 2  
Piston which has had contact with the cylinder head



Fig. 3  
Piston snapped off at a right angle at the height of the piston pin axis

## 3.6 Cracks in the top of the piston

### DESCRIPTION

- There are cracks in the top of the piston (*Fig. 1*).
- The piston is broken in the piston pin bore (*Fig. 2*).
- There are cracks at the bowl rim (*Fig. 3a+b*).

### PROBABLE CAUSES

The cracks result from mechanical or thermal overload of the piston.

#### Mechanical overload:

Mechanical overload of the piston is often caused by tuning.

- Excessive engine tuning results in piston overload particularly in the piston pin bore. This leads to cracks in the pin bore or a cleavage fracture along the piston in the piston pin bore.
- The weight of the piston pin is reduced, resulting in oval distortion of the piston pin and subsequent “bursting” of the piston in the piston pin bore.
- Due to the reduction in piston weight, forces can no longer be absorbed, creating cracks in the material.

#### Thermal overload

Due to incorrect functioning of the injection system, tuning or start assistance for diesel engines, there is an excessive amount of fuel in the combustion chamber which in turn leads to highly alternating thermal stress of the piston. This creates stress cracks in the material.

### REMEDY/PREVENTION

- Tuning and the required engine modifications should only be carried out by the engine manufacturer or trained and qualified engine tuners.
- Set the injection pump according to the manufacturer’s specifications.



*Fig. 1*  
Cracks in the bowl rim





Fig. 2  
Piston fractured right into the pin bore



Fig. 3a  
Cracks in the bowl rim



Fig. 3b  
Close-up view

## 4 Piston skirt

### 4.1 Piston seizure on the thrust and opposite side (piston skirt area only)

#### DESCRIPTION

- Seizure at the piston skirt with scoring marks on the thrust and opposite side (Fig. 1).
- The seizure marks show as partially shiny areas, as if they have been polished (Fig. 2).
- The seizure is concentrated at the end of the skirt.
- The piston rings and the piston ring belt are in good condition.

#### PROBABLE CAUSES

The damage is caused by localized hot spots. Since the piston crown and the top of the piston are undamaged, the problem cannot be attributed to an abnormal combustion. There are two other possible causes:

##### Seizure caused by a lack of clearance (overheating):

The engine has overheated because:

- The coolant level is too low.
- The coolant circulation is faulty, e.g. due to a defective water pump, a loose or torn V-belt, a defective thermostat, a damaged viscous clutch or a defective fan.
- The engine ventilation is incorrect.

Since the aluminum of the piston expands with heat at twice the rate of the gray cast iron of the cylinder, an excessively high thermal load (cold engine, hot piston) can result in piston seizure.

##### Seizure caused by a lack of clearance (machining defect):

The cylinder bore is machined to the incorrect size (piston diameter plus fitting clearance).

#### REMEDY/PREVENTION

- Always observe the correct cylinder size. This can be determined using the values stated on the piston (piston diameter plus fitting clearance).
- Check the coolant circuit, this includes:
  - Coolant level
  - Water pump (V-belt)
  - Thermostat
  - Fan
- Deaerate the cooling system. This also includes the heating circuit.



Fig. 1  
Seizure at the piston skirt, caused by insufficient clearance



Fig. 2  
Partially shiny seizure marks

## 4.2 Piston seizure on one side of the piston skirt

### DESCRIPTION

- Piston seizure only shows on the thrust side of the piston skirt (Fig. 1).
- There are burn marks on the piston rings (Fig. 2).
- An excellent wear pattern is visible on the opposite side.

### PROBABLE CAUSES

Since the load on the thrust side of the piston during the power stroke is greater than on the opposite side, inadequate lubrication becomes apparent on the thrust side first. This can be the result of the following:

- The cylinder wall was inadequately lubricated. This can be the result of a low level of oil, excessive engine warm-up or a clogged oil feeder hole in the connecting rod and/or the cooling oil nozzle.
- The oil has been diluted with either fuel or condensation water (also see section “2.2 Fuel flooding”, page 8). The load-bearing ability of the oil film is therefore considerably reduced.
- Oil which is not suitable for the engine loads, i.e. with an insufficient lead-bearing ability, has been used.
- The finned cylinder for an air-cooled engine has locally overheated, e.g. due to broken off or dirty fins.

### REMEDY/PREVENTION

- Ensure a correct supply of oil – and check that the oil feeder holes in the connecting rod are not clogged.
- Only use engine oils approved by the engine manufacturer.
- Operate the engine at a moderate speed and load immediately after assembly.
- Regular oil level checks are imperative; if necessary, refill oil.
- Check the oil pressure. Insufficient oil pressure can be caused by a worn oil pump, a dirty filter, a defective pressure relief valve in the oil pump or diluted oil.
- Check the cooling system.



Fig. 1  
Seizure only on the thrust side of the piston skirt



Fig. 2  
Piston rings with burn marks

## 4.3 Diagonal piston seizure next to the pin bore

### DESCRIPTION

- There are only diagonal seizure marks next to the pin bore (Fig. 1).
- There are usually no seizure marks on the piston skirt in the thrust and opposite direction (Fig. 2).
- In addition to the seizure marks, some surfaces have a shiny appearance.
- It is very difficult to move the connecting rod around the piston pin axis.
- There are seizure marks in the pin bore (Fig. 3).

### PROBABLE CAUSES

Damage occurs when the load-bearing ability of the oil film between the piston and the running surface is inadequate in the piston pin boss area. The cause is usually piston overheating in the pin boss area, resulting in the lubricating oil film being extruded. A piston may overheat during operation due to the following reasons:

- The clamp type connecting rod is installed incorrectly, e.g. if the piston and the connecting rod have been moved directly after shrink in. Due to temperature compensation, the piston pin can become very hot and expand accordingly, therefore causing seizure in the pin bore.
- Cylinder distortion can seriously restrict the running clearance. Since the area around the pin boss is the most rigid, the piston can only give slightly in this area.
- If the piston pin has not been sufficiently oiled prior to engine assembly, there may be inadequate lubrication between the piston pin and the piston when starting up the overhauled engine. This causes seizure in the pin boss, resulting in an increased temperature in the pin bore area.
- The warm-up period at idle speed has been too long.

### REMEDY/PREVENTION

- Always oil the connecting rod, the piston pin and the pin boss sufficiently immediately prior to engine assembly and make sure that unrestricted movement is guaranteed.
- Pump oil into the assembled engine under pressure to ensure that oil is pushed through the oil filter and all the oil feeder holes.
- Operate the engine at a moderate speed and load immediately after assembly.

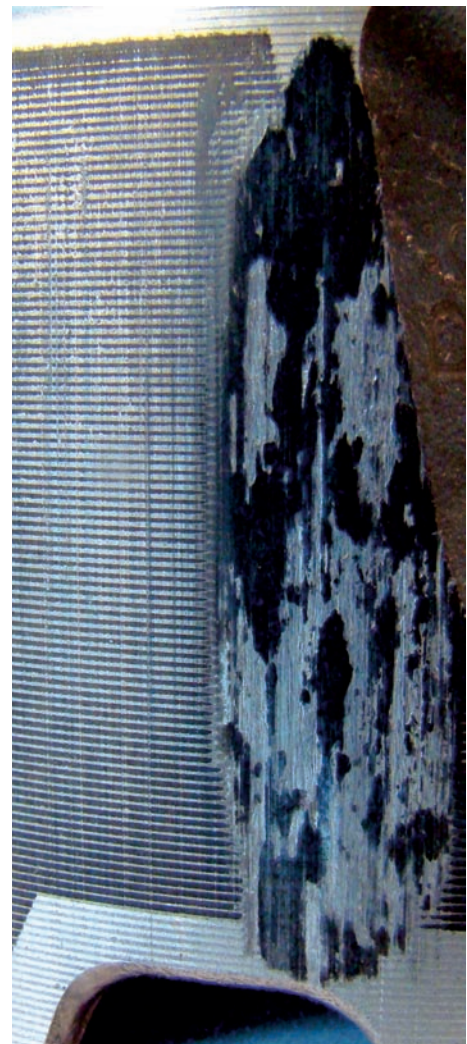

Fig. 1  
Diagonal seizure marks next to the pin bore



Fig. 2  
Lateral piston seizure next to the pin bore



Fig. 3  
Pin bore with seizure marks

## 4.4 Asymmetrical wear pattern on the piston skirt

### DESCRIPTION

- The piston skirt shows an asymmetrical wear pattern (*Fig. 1*).
- The top land has a shiny appearance on one side of the piston and is blackened by oil carbon on the opposite side (*Fig. 2*).

### PROBABLE CAUSES

Due to geometrical irregularities in the piston guidance, the piston no longer travels straight in the cylinder. This means that one side of the piston has contact with the cylinder, while at the opposite side a large gap appears through which hot exhaust gases (blow-by gases) travel, baking the oil film. The pistons rings, which also travel at an angle, vibrate and create a pumping motion, causing increased oil consumption (also see section "2.4 Increased oil consumption", page 12). Incorrect travel can be caused by the following:

- The bores in the 'small end' and 'big end' of the connecting rod are not parallel. Alignment deviations arise,
  - because the connecting rod is bent or twisted, or
  - because the connecting rod end has been bored at an angle.
- The main bearing line displays a slanted bearing which can, e.g., be caused by worn bearing shells.
- The cylinder head bolts have been tightened incorrectly (incorrect sequence or incorrect tightening torque). Caution: Air-cooled finned cylinders are particularly susceptible.
- The cylinder base of the finned cylinder is contaminated. The finned cylinder is therefore positioned at an angle on the crankcase, and the piston is not straight in the cylinder bore (slanted position).

### REMEDY/PREVENTION

- Align the main bearing line, the crankshaft and the connecting rod properly during machining and installation (concentricity).
- Make sure that the connecting rod is aligned correctly.
- Tighten the cylinder head bolts according to the manufacturer's specifications.
- Always pay great attention to cleanliness during engine assembly, e.g. gasket residue must be cleaned up immediately.



*Fig. 1*  
Asymmetrical wear pattern (slanted position)  
at the piston skirt



*Fig. 2*  
Top land with irregular  
deposits

## 4.5 Piston seizure in the lower piston skirt area only

### DESCRIPTION

- A sharp-edged seizure shows in the lower piston skirt area (Fig. 1).
- There is a continuous, shiny edge in the cylinder bore (Fig. 2).

### PROBABLE CAUSES

These marks are caused by insufficient clearance between the piston and the cylinder bore which may result from the following:

If the space in the gasket groove is inadequate, the cylinder liner becomes constricted. This can be attributed to:

- the application of an incorrect (too thick) gasket,
- the application of additional sealants,
- a gasket which has slipped, or
- gasket residue which has not been removed.

If the cylinder head bolts are tightened incorrectly and/or unevenly – especially with finned cylinders – there is a higher risk of cylinder distortion.

An incorrectly set honing machine, e.g. with idle travel of the honing stones, can result in the bore diameter at the end of the cylinder being too small.

### REMEDY/PREVENTION

- Tighten the cylinder head bolts according to the tightening torque specifications.
- To prevent a lack of clearance or cylinder distortion, install wet cylinder liners without gaskets first. This ensures that a lack of clearance can be detected in good time. Subsequently insert the cylinder liner together with the gaskets.
- Set the honing machine correctly. Measure the cylinder bore at the top, middle and bottom, also in two directions, during and after honing.



Fig. 1  
Seizure at the lower piston skirt due to constriction of the cylinder liner



Fig. 2  
Continuous, shiny line at the cylinder bore

## 4.6 Heavy wear at the piston skirt with a rough, matte surface

### DESCRIPTION

- The engine requires an increased amount of oil (also see section “2.4 Increased oil consumption”, page 12).
- The engine provides poor performance and incorrect starting behavior, particularly at low ambient temperatures.
- Both sides of the piston skirt show a matte, wide wear pattern (Fig. 1).
- The machining profile is partially removed.
- There are fine scoring marks on the piston skirt.
- The piston rings have a large end gap and show radial wear.
- The faces of the oil control ring are heavily worn.
- The groove walls show axial wear.

### PROBABLE CAUSES

This type of damage is due to wear caused by contamination. Depending on the number of damaged cylinders and the amount of the piston ring wear, it is possible to distinguish between several types of wear:

#### If only one cylinder is damaged...

**...and the top ring is more worn than the oil control ring,** contamination has reached the combustion chamber via the intake system of one cylinder, i.e. from above. This is caused either by a leak or debris which was not removed prior to assembly.

#### If several or all the cylinders are damaged...

**...and the top ring is more worn than the oil control ring,** contamination has reached the combustion chamber via the common intake system of all the cylinders. This is either due to leaks and/or a defective or missing air filter.

**...and the oil control ring is more worn than the top ring,** contaminated engine oil is the culprit. The oil is contaminated either due to an uncleaned crankcase and/or a dirty oil mist separator.

### REMEDY/PREVENTION

- Check the intake system for leaks.
- Check the air filter and, if necessary, replace it.
- Clean the crankcase and the intake manifolds prior to assembly.
- Always pay attention to cleanliness during assembly.



Fig. 1  
Wear caused by contamination at the piston skirt



## 4.7 Wear marks on one side of the piston skirt

### DESCRIPTION

- The wear pattern is wide and shiny (*Fig. 1*).
- There are deep, lengthwise scoring marks along the entire length of the piston skirt and around the whole piston.
- The piston rings show scoring marks and even some burn marks (*Fig. 2*).

### PROBABLE CAUSES

An excessive amount of fuel in the oil dilutes the oil film, thus drastically reducing its load-bearing ability and increasing engine component wear. This type of damage can have the following causes:

- The injection system is set incorrectly.
- The cold start enrichment is too rich.
- The injection nozzles are functioning incorrectly, for example due to a clogged fuel filter.
- Due to an excessive protrusion, the piston hammers the cylinder head, causing uncontrolled injection.
- The compression pressure is too low, which can result in misfiring. This can be attributed to the following conditions:
  - A valve is leaky.
  - The cylinder head gasket is leaky.
  - The timing is set incorrectly.
  - The protrusion is too small.
  - One piston ring or several piston rings are defective.
  - An error has occurred in the ignition system, e.g. a defective spark plug.
  - The engine is worn.

### REMEDY/PREVENTION

- Set the injection system correctly (cold start enrichment, etc.).
- Check the injection nozzles.
- Always observe installation dimensions.
- Always adhere to fuel filter maintenance intervals, and shorten intervals accordingly in extreme conditions.
- Check the spark plugs and, if necessary, replace them.

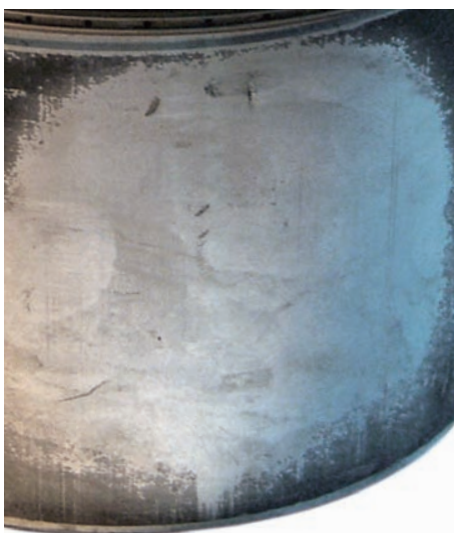

*Fig. 1*  
Wide, shiny wear pattern  
and scoring marks



*Fig. 2*  
Scoring marks and burn marks on the piston rings

## 5 Support – piston pin bushing

### 5.1 Seizure in the pin bore

#### DESCRIPTION

The piston shows seizure marks in the pin bore, particularly in the upper section (*Fig. 1*).

#### PROBABLE CAUSES

- The piston pin has not been oiled sufficiently prior to assembly (also see section “4.3 Diagonal piston seizure next to the pin bore”, page 28).
- The load-bearing ability of the oil film is considerably reduced due to fuel dilution (also see section “2.2 Fuel flooding”, page 8).
- The connecting rod bushing has not been machined to the specified dimension, i.e. the diameter is too small. This means that the piston pin can only move freely in the piston.
- The oil supply is interrupted due to incorrectly fitted bearings (main bearing/connecting rod bearing/connecting rod bushing) (also see section “9.8 Seizure at bearings”, page 59).
- Low quality oil, which does not satisfy the specified requirements, has been used.
- The oil film in the pin bore has been destroyed by the forces, heat and abrasion generated by a piston seizure.

This type of damage is a preliminary stage of the damage described in section 4.3 “Diagonal piston seizure next to the pin bore”, page 28.

#### REMEDY/PREVENTION

- During assembly, ensure there is sufficient clearance between the piston pin and the connecting rod bushing.
- Oil the piston pin sufficiently prior to engine assembly.
- Pay attention to the installation direction of the bearings (oil feeder hole, oil grooves).
- Only use engine oil approved by the engine manufacturer.

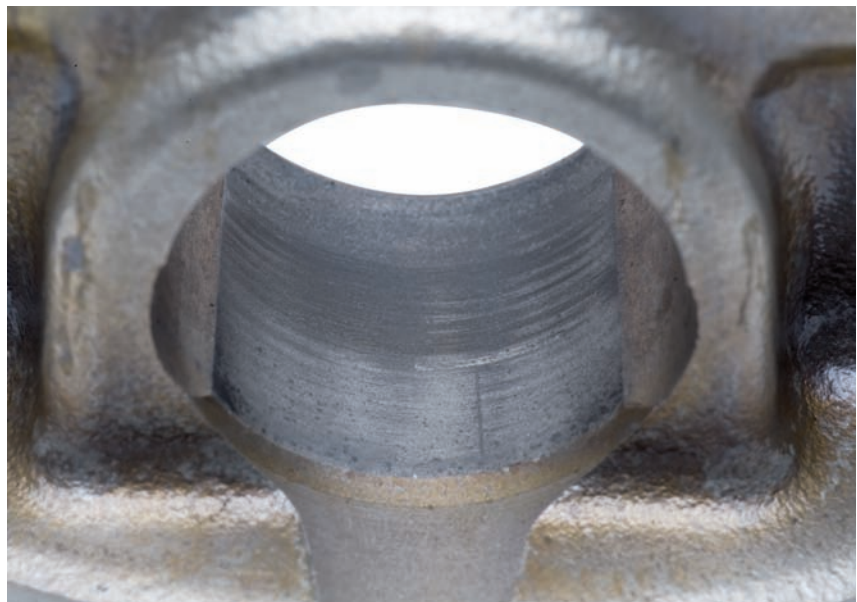

*Fig. 1*  
Seizure in the pin bore

## 5.2 Cratered piston wall in the pin boss area

### DESCRIPTION

- The piston is cratered in the area around the pin bosses (Fig. 1a).
- The damage migrates up to the piston ring belt.
- The surface is shiny and smooth (Fig. 1b).
- The piston rings may also be damaged.

### PROBABLE CAUSES

This type of damage is caused by loose piston components in the pin bore area, e.g. due to contamination, or a piston pin circlip has come loose due to over-speeding or an assembly error.

#### Over-speeding:

Over-speeding can cause resonance vibrations at both ends of the piston pin circlip, pushing it out of the circlip groove.

#### Assembly error:

- A circlip has been fitted incorrectly.
- There is no circlip in the groove or the circlip is fractured.
- Old, previously used circlips have been re-used.
- An overload fracture occurred in the circlip groove area during piston pin assembly.
- The connecting rod is not straight (also see section “4.4 Asymmetrical wear pattern on the piston skirt”, page 30).

### REMEDY/PREVENTION

- When installing the circlips, ensure that the circlip ends face “6 o’clock” or “12 o’clock”.
- Always fit new, perfectly shaped circlips.
- Never use force to insert the piston pin, e.g. with a hammer.
- Make sure the bores are parallel before assembling the connecting rod.



Fig. 1a  
Cratered piston wall, caused by a loose piston pin circlip or contamination in the piston pin



Fig. 1b  
Close-up surface view of softer piston material and harder piston ring material worn to the same extent

## 6 Piston rings

### 6.1 Piston rings with burn marks and seizure marks on the piston skirt

#### DESCRIPTION

- There are scoring marks and burn marks on the outer surface of the piston rings (*Fig. 1*).
- Seizure marks are visible on the piston skirt.
- There are longitudinal scoring marks in the cylinder bore (*Fig. 2*).

#### PROBABLE CAUSES

Burn marks at the piston rings usually occur in connection with other piston or cylinder damage. The burn marks at the piston rings are the result of inadequate lubrication caused by the following:

- The engine has been heavily loaded during the break-in phase. Since the piston rings have not achieved their full sealing effect during this phase, the hot combustion gases (blow-by gases) can blow past the piston and bake the lubricating oil film. In addition to piston ring scuffing, piston seizure can also occur.
- Honing is incorrect, resulting in insufficient engine oil on the cylinder wall.
- The lubricating oil film has been diluted due to fuel flooding (also see section "2.2 Fuel flooding", page 8).
- The piston rings show abrasion caused by a slanted position (also see section "4.4 Asymmetrical wear pattern on the piston skirt", page 30).
- The piston is overheated due to an abnormal combustion, and engine oil has been carbonized in the ring grooves. This obviously restricts piston ring movement.

#### REMEDY/PREVENTION

Avoid high speeds or high loads at low speeds (RPM's) during the break-in phase.

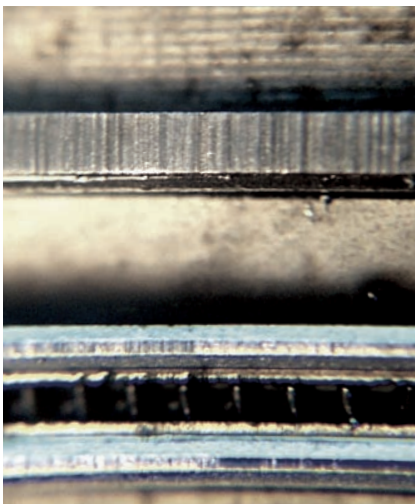

*Fig. 1*  
Piston rings with scoring marks and burn marks

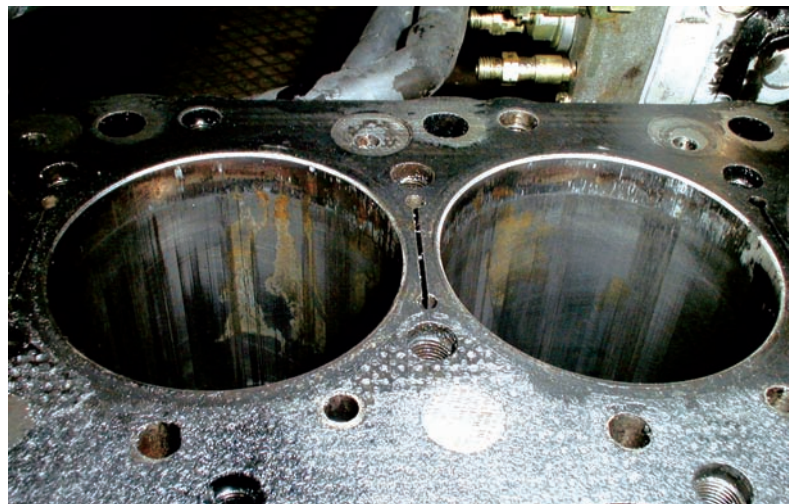

*Fig. 2*  
Cylinder bore with longitudinal scoring marks

## 6.2 Damage to the piston ring belt due to fractured piston rings



Fig. 1  
Heavily worn piston ring groove



Fig. 2  
Ring belt with shiny surface



Fig. 3  
Damage to the top of the piston due to individual fragments of the ring insert

### DESCRIPTION

- A depression has been worn into the piston ring lands and/or the top land (Fig. 1).
- The surfaces of the worn area are shiny and smooth (Fig. 2).
- Further damage includes the impact of piston ring fragments on the top of the piston (Fig. 3).
- The piston ring of the worn groove is fractured (Fig. 4a+b).

### PROBABLE CAUSES

The damage is caused by a piston ring fracture or by piston ring vibration. Possible reasons are:

#### Assembly error:

The piston ring was not fully inserted into the piston ring groove during assembly and broke while being pushed into the cylinder.

#### Knocking:

The piston ring fracture has been caused by pressure peaks during knocking (Fig. 4b).

#### Piston ring vertical clearance:

- The piston ring grooves are worn.
- The piston ring is worn.
- The thermal overload of the engine reduces the material strength, and the grooves are worn out.

### REMEDY/PREVENTION

- Always use a ring compressor during assembly.
- Check the piston ring grooves for wear prior to assembly. Always use a new piston if the piston ring grooves are heavily worn.

Fig. 4a  
Piston ring fracture caused by knocking

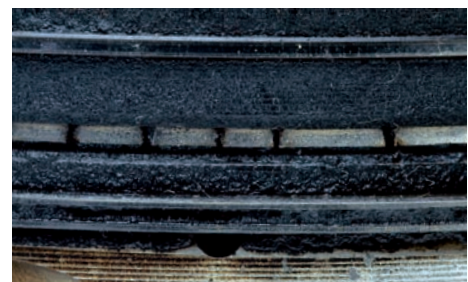

Fig. 4b  
Close-up view of a piston ring fracture

## 6.3 Heavy wear of the piston ring grooves and piston rings

### DESCRIPTION

- The piston rings exhibit heavy radial wear (*Fig. 1*). This can result in the end gap increasing by several millimetres.
- There is heavy axial wear at the piston rings and the groove walls (*Fig. 2*).
- The engine displays increased oil consumption (also see section “2.4 Increased oil consumption”, page 12) in connection with a loss of performance.

### PROBABLE CAUSES

This type of damage is due to wear caused by contamination. Depending on the number of damaged cylinders and the amount of the piston ring wear, it is possible to distinguish between several types of wear:

#### If only one cylinder is damaged...

**...and the top ring is more worn than the oil control ring,** contamination has reached the combustion chamber via the intake system of one cylinder, i.e. from above. This is caused either by a leak or debris which was not removed prior to assembly.

#### If several or all the cylinders are damaged...

**...and the top ring is more worn than the oil control ring,** contamination has reached the combustion chamber via the common intake system of all the cylinders. This is either due to leaks and/or a defective or missing air filter.

**...and the oil control ring is more worn than the top ring,** contaminated engine oil is the culprit. The oil is contaminated either due to an uncleaned crankcase and/or a dirty oil mist separator.

### REMEDY/PREVENTION

- Check the intake system for leaks.
- Check the air filter and, if necessary, replace it.
- Clean the crankcase and the intake manifolds prior to assembly.
- Always pay attention to cleanliness during assembly.

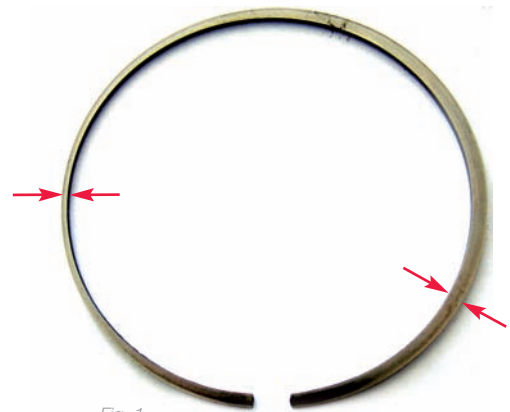

Fig. 1  
Piston ring with heavy radial wear



Fig. 2  
Heavy axial wear particularly at the top ring

## 6.4 Heavy radial wear of the piston rings

### DESCRIPTION

- The piston rings exhibit heavy radial wear (*Fig. 1*).
- The running surfaces of the piston rings show partial burn marks (*Fig. 2*).
- There is only slight axial wear of the piston rings.
- The axial wear of the groove walls is also relatively low.
- The faces of the oil control ring are possibly worn.
- There is heavy scoring of the piston skirt, possibly combined with scuffing or seizure marks.

### PROBABLE CAUSES

An excessive amount of fuel in the oil dilutes the oil film, thus drastically reducing its load-bearing ability and increasing engine component wear. This type of damage can have the following causes:

- The injection system is set incorrectly.
- The cold start enrichment is too rich.
- The injection nozzles are functioning incorrectly, for example due to a clogged fuel filter.
- Due to an excessive piston protrusion, the piston hammers the cylinder head, causing uncontrolled injection.
- The compression pressure is too low, which can result in misfiring. This can be attributed to the following conditions:
  - A valve is leaky.
  - The cylinder head gasket is leaky.
  - The timing is set incorrectly.
  - The piston protrusion is too small.
  - One piston ring or several piston rings are defective.
  - An error has occurred in the ignition system, e.g. a defective spark plug.



*Fig. 1*  
Heavy radial wear with relatively low axial wear



*Fig. 2*  
Scoring marks and burn marks on the piston rings

### REMEDY/PREVENTION

- Set the injection system correctly (cold start enrichment, etc.).
- Check the injection nozzles.
- Always observe installation dimensions.
- Always adhere to fuel filter maintenance intervals, and shorten intervals accordingly in extreme conditions.
- Check the spark plugs and, if necessary, replace them.

## 7 Cylinder liners

### 7.1 Grains on the outer wall of cylinder liners (cavitation)

#### DESCRIPTION

Wet cylinder liners have hollow spaces or cavities in the water jacket area (cavitation, Fig. 1a+b); however, these are usually only visible at the thrust and/or opposite side in the area around the top or bottom dead center of the piston.

#### PROBABLE CAUSES

The cavitation damage (pitting) is caused by vibrations of the cylinder liner. These vibrations can occur at the cylinder wall due to the contact alteration of the piston in the top and bottom dead center and be transmitted to the surrounding water jacket. When the cylinder wall moves back during a vibration cycle, a vacuum forms for a brief instance, resulting in vapor bubbles in the water. When the coolant column vibrates back, the vapor bubbles implode and the water flooding back onto the cylinder liner causes material erosion. Cavitation damage is promoted by the following points:

- Insufficient anti-freeze in the coolant which could reduce the formation of vapor bubbles.
- The cooling system, e.g. the radiator cap, has a leak. This prevents pressure forming in the cooling system, promoting the formation of vapor bubbles.
- The cylinder liner in the crankcase has excessive clearance. Therefore, the vibrations caused by the contact alteration of the piston cannot be sufficiently absorbed.
- An incorrect coolant (acidic water, etc.) has been used.
- The engine is operating in an insufficient temperature range. Therefore, the pressure level of the coolant is too low, promoting the formation of vapor bubbles. The piston does not reach its operating temperature, has excessive clearance and displays insufficient smoothness during contact alterations. An insufficient temperature range can be caused by the following:
  - The thermostat or the thermo switch is defective.
  - The viscous clutch of the fan wheel is defective, i.e. the fan wheel is driven permanently.

#### REMEDY/PREVENTION

- Always check the cooling system (radiator cap, hoses, clamps) for leaks.
- Ensure there is sufficient anti-freeze with corrosion protection.
- Make sure the cooling system is functioning correctly (thermostat, fan, thermo switch).





*Fig. 1a*  
Cylinder liner with cavitation damage



*Fig. 1b*  
Close-up view of the cylinder liner with sharp edges and cavities which become larger towards the inside

## 7.2 Snapped off flange of cylinder liners

### DESCRIPTION

- The cylinder liner is snapped off below the flange (Fig. 1).
- The fracture runs at an approx. 30° angle (Fig. 2).
- The fracture shows a coarse structure.

### PROBABLE CAUSES

This overload fracture was caused by a bending moment in the flange seat. The bending moment can be caused by the following:

Contamination between the cylinder liner and the flange seat (e.g. dirt, gasket residue, chips, etc.).

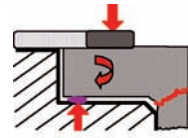

The sharp edge of the flange seat has not been chamfered after machining.

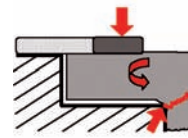

The flange seat is slanted.

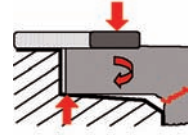

The cylinder head gasket is too large.

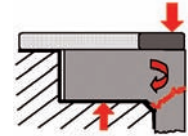

The seat of the fire-ring in the cylinder head has not been cleaned or re-machined.

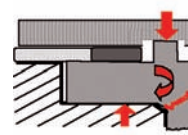

Due to a large amount of cylinder liner retraction, the cylinder liner does not sit correctly in the seat, resulting in strong impact impulses.

### REMEDY/PREVENTION

- Always ensure precise machining of the flange seat in the engine block.
- Make sure that the cylinder liner seat is plane and rectangular.
- After machining, the sharp-edged seat surface must be chamfered.
- Only use the cylinder head gaskets recommended for the engine.



Fig. 1  
Snapped off cylinder liner flange

approx. 30°

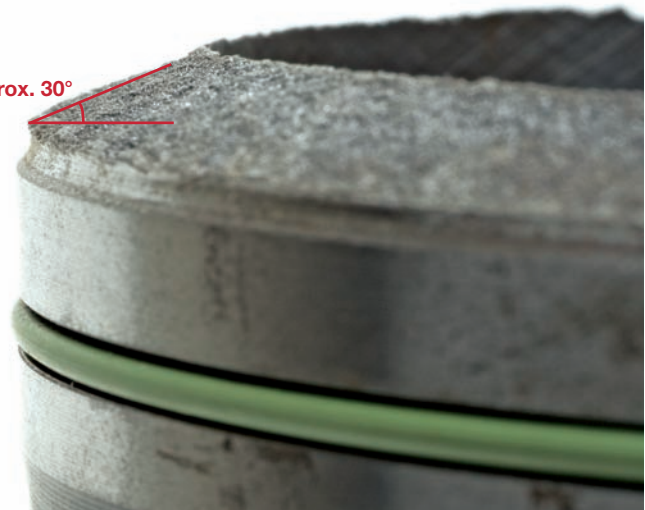

Fig. 2  
Fracture with a coarse structure at an angle of approx. 30°

## 7.3 Longitudinal cracks in the cylinder liners

### DESCRIPTION

There is a longitudinal crack in the cylinder liner (Fig. 1).

### PROBABLE CAUSES

#### Longitudinal crack from the upper or lower end of the cylinder liner:

Damages caused by improper handling of the cylinder liner during transport or repairs, e.g. falling onto a hard floor. The generated stresses in the cylinder liner material can result in the aforementioned damage.

#### Longitudinal crack in the piston running area:

Hydraulic lock (also see section “2.3 Hydraulic lock”, page 10) generates enormous forces in the combustion chamber. Since water cannot be compressed, the adjacent components, including the cylinder liner, must absorb the resulting forces. This can lead to the cylinder liner actually ‘bursting’.

### REMEDY/PREVENTION

- Cylinder liners must be transported carefully and only in an upright position.
- Always carry out a ring test before installing the cylinder liner. Also carry out a visible inspection of the cylinder liner surface.



Fig. 1  
Lower end of the cylinder liner with a longitudinal crack

## 8 Valves

### 8.1 Valve stem scuffing

#### DESCRIPTION

The valve stem shows seizure or scuffing marks (*Fig. 1a+b*).

#### PROBABLE CAUSES

There are basically two causes:

##### Geometrical irregularities:

- The valve guide and the valve seat are not aligned. This can be caused either by improper machining or by dirt in the valve guide and/or valve seat.
- The valve is slanted or bent which can, e.g., be caused by valve impact. A hardly visible bend can nonetheless lead to a concentricity deviation of the valve.
- A loose valve seat insert results in misalignment to the valve guide.
- The internal diameter of the valve guide is either too big or too small, causing excessive or insufficient clearance between the valve and the valve guide.
- Old or worn out valve keepers have been used.

##### Over-speeding:

- Over-speeding can result in the breakdown of the tribological system. The lubricating oil film between the valve guide and the valve can no longer withstand the rapid movement, and there is metallic contact between the valve and the valve guide.
- Valve impacts are caused by over-speeding (see above “geometrical irregularities”).

#### REMEDY/PREVENTION

- Align the valve guide and the valve seat correctly.
- When re-machining used valves, pay great attention to a straight valve stem.
- Install the valve seat inserts according to the manufacturer's specifications.
- Always use new valve keepers. Old keepers are usually worn unevenly so that the valves cannot rotate freely.
- Always machine valve guides to specified dimensions according to the manufacturer's instructions.
- After running the engine above the rated speed, it is advisable to check the entire valve train system and the top of the piston for damage.



*Fig. 1a*  
Valve with seizure in the guide



*Fig. 1b*  
Clearly visible in the close-up view: Deposit build-up and seizure marks on the valve stem

## 8.2 Distortion at the valve stem

### DESCRIPTION

- The valve stem shows slight curvature or is bent (*Fig. 1*).
- The valve head has been snapped off (*Fig. 2–3*).

### PROBABLE CAUSES

Distortion at the valve stem is caused by mechanical overload. This can be attributed to the following:

- An incorrect valve setting can result in valve impacts at the piston.
- At over-speeding of the engine the return speed of the valve springs is insufficient and the piston and the valve collide.
- The timing is set incorrectly, i.e., the markings have not been observed so that the valve train and the piston movements are no longer synchronized, resulting in valve impacts.
- The timing belt or the chain has jumped due to a defective clamping device.
- The timing belt or chain has been damaged.
- The valve depth is insufficient.

### REMEDY/PREVENTION

- Set the valve clearance correctly.
- Avoid running the engine above the rated speed.
- Set the timing correctly.
- Always renew the clamping device when replacing timing belts or chains.
- After machining the cylinder head, always check the valve depth.



*Fig. 1*  
Bent valve stem



*Fig. 2*  
Snapped off valve head



*Fig. 3*  
Vibration fracture with fracture surface at the valve stem

## 8.3 Fracture in the valve groove



Fig. 1  
Heavily deformed  
valve



Fig. 2  
Valve base broken in the groove (overload fracture/bending stress)



Fig. 3  
Deformation of the valve keepers at the ribs

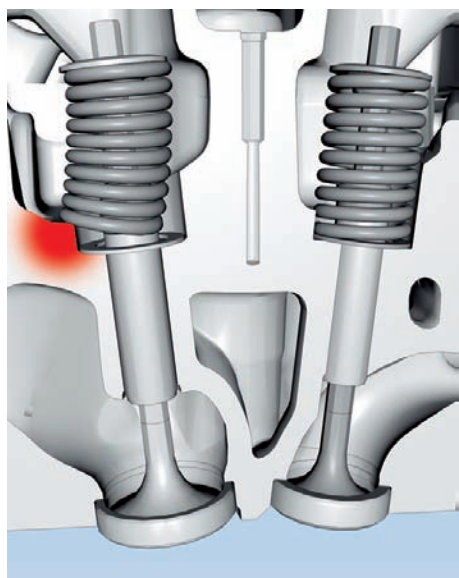

Fig. 4  
Slanted spring sticking on one side

### DESCRIPTION

The valve exhibits a groove fracture or it has been snapped off (Fig. 1–2). The valve keepers are deformed (Fig. 3).

### PROBABLE CAUSES

This type of damage can only be caused by mechanical overload of the valve. Two conditions are responsible for this:

#### Coarse fracture structure – assembly fault:

- There is an overload fracture, characterized by a coarse fracture structure. This is due to an assembly error and occurs shortly after repairing the engine. If the valve spring is positioned at an angle, it will stick on one side when compressed. This results in a large bending moment at the valve spring retainer. This bending moment can cause the valve to fracture or snap (Fig. 4–5).

#### Fine fracture structure – geometry fault:

- There is a fatigue fracture, characterized by a fine fracture structure. The fatigue fracture is caused by a geometry fault in the valve train system. For example, if the valve head is no longer at a perfect right angle to the valve stem due to slight contact between the valve and the piston, bending will occur at the transition area between the valve head and the valve stem when the valve strikes the seat. During longer operation this can lead to material fatigue and the valve being snapped off.
- Slanted rocker arms or the application of used valve keepers can also cause a slight bending moment at the valve. During longer operation this can lead to the valve being snapped off.

### REMEDY/PREVENTION

- Position the valve springs correctly during installation.
- Check the valve train system.
- Always use new valve keepers. Old valve keepers are usually worn unevenly so that the valves cannot rotate freely, resulting in bending stress at the valve stem.



Fig. 5  
Marks at the cylinder head caused by an  
incorrectly inserted valve spring

## 8.4 Fracture in the valve head area

### DESCRIPTION

The valve is snapped off and/or bent in the valve head area (*Fig. 1*).

### PROBABLE CAUSES

The type of damage is caused by mechanical overload of the valve. There are two overload types:

#### Coarse fracture structure – overload fracture:

- This occurs due to a short, quick and very high force, such as valve impact on the piston (also see section “3.5 Valve impacts at the top of the piston and piston hammering at the cylinder head”, page 22). This is caused by incorrectly set timing, incorrect valve depth or running the engine above the rated speed.

#### Fine fracture structure – fatigue fracture:

- The valve bends while closing due to slight valve deformation in the transition area between the valve head and the valve stem. This results in material fatigue and causes the valve to snap off.

### REMEDY/PREVENTION

- Set the timing correctly during assembly.
- Always check the valve depth carefully during cylinder head repair work.
- Avoid over-speeding.
- If valves are reused, always check their dimensional accuracy.
- Machine the valve seat carefully, ensuring the valve guide and the valve seat are aligned correctly.



*Fig. 1*  
Snapped off valve in the valve head area



## 8.5 Valve seat wear

### DESCRIPTION

- The sealing surface at the valve is heavily worn (*Fig. 1–3*).
- The valve keepers are deformed.

### PROBABLE CAUSES

The valve seat is worn by excessive component loading. This loading can be caused by:

- The valve guide and the valve seat display geometrical irregularities, i.e. they are not aligned.
- The temperature level is too high, e.g. due to:
  - an incorrect mixture setting,
  - an abnormal combustion,
  - an insufficient valve clearance,
  - knocking, or
  - tuning.
- The valve seat is subject to excessive mechanical loads, e.g. reinforced valve springs or sharp camshafts.
- After converting the engine to gas-fuelled operation (LPG, CNG, etc.), the lack of evaporation cooling or the missing lubricating effect of the fuel means the valve becomes hotter and is subject to greater loads.

### REMEDY/PREVENTION

- Make sure the valve guide and the valve seat are aligned.
- Set the valve clearance according to specifications.
- Only use parts approved by the manufacturer (springs, camshafts, etc.).
- The valves and valve seat inserts must be suitable for gas-fuelled operation (LPG, CNG, etc.).

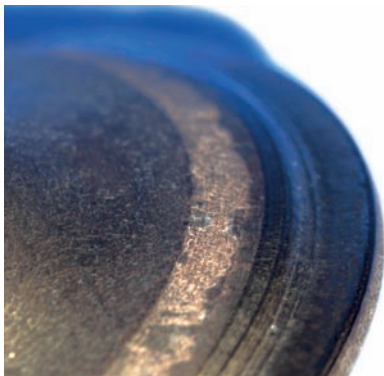

Fig. 1  
Heavy wear on the sealing surface

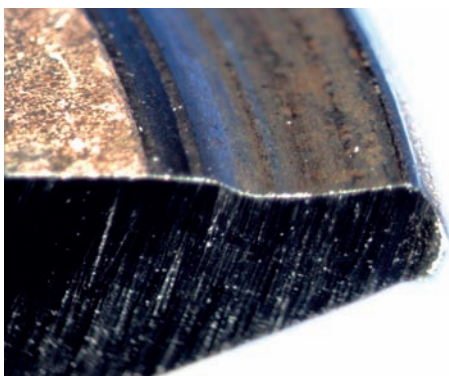

Fig. 2  
Detailed view of the sealing surface



Fig. 3  
Heavily worn sealing surface (stellite hardened)

## 8.6 Deformation of the valve head

### DESCRIPTION

The valve head is deformed and/or fractured (Fig. 1–3).

### PROBABLE CAUSES

The valve head is deformed due to either thermal or mechanical overload.

This overload can be caused by the following:

#### Thermal overload:

- The valve clearance is insufficient.
- An abnormal combustion has occurred.
- An attempt has been made to increase power by tuning.

#### Mechanical overload:

There is contamination wedged in between the valve and the valve seat.

### REMEDY/PREVENTION

- Set the valve clearance correctly.
- Check the injection system.
- Always remove any remaining small parts from the combustion chamber or intake passage during engine assembly.



Fig. 1  
Deformed valve head (tulip-shaped)

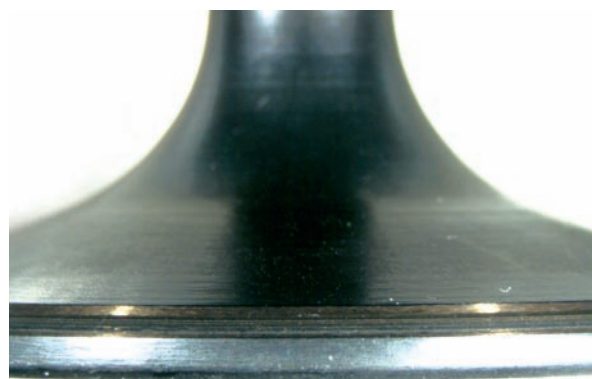

Fig. 2  
For comparison: Valve head without deformation



Fig. 3  
Linear contact marks at a deformed valve head

## 8.7 Hole burned through the valve head

### DESCRIPTION

A wedge-shaped piece has melted off at the valve head (Fig. 1).

### PROBABLE CAUSES

This type of damage is the result of thermal overload of the valve, which may be caused by the following:

#### **Leaky valve:**

The valve no longer seals properly due to a poorly re-machined valve seat, an incorrectly set valve clearance, a small fracture in the valve head or other geometrical irregularities. A lack of clearance between the valve guide and the valve stem can also restrict valve rotation. Due to insufficient or non-existent contact between the valve head and the valve seat insert in the cylinder head, the valve is unable to distribute heat, resulting in heat accumulation at the valve head, this in turn causes the valve head to melt during prolonged operation.

#### **Valve rotation is restricted:**

Valves with three grooves require rotation. If old valve keepers are used during assembly, there is a risk that the valves can no longer rotate. This may create heat accumulation which can cause the valve to melt during prolonged use.

### REMEDY/PREVENTION

- When re-machining the valve seat, always ensure concentricity between the valve guide and the valve seat.
- Always use new valve keepers. Old valve keepers are usually worn unevenly so that the valves cannot rotate freely.
- Ream the valve guide to the specified dimension using a reamer.



Fig. 1  
Hole burned through  
the valve

## 9 Bearings

### 9.1 Scoring and contamination at the running surface of bearings

#### DESCRIPTION

On the running surface of the bearings there are scoring marks in circumferential direction and embedded contamination in the bearing material (Fig. 1).

#### PROBABLE CAUSES

This type of damage is caused by contamination in the oil. This can reach the oil circuit due to various reasons:

- Contamination has entered the engine when carrying out work at the vehicle.
- Contamination has entered via the intake system or the crankcase ventilation.
- Other engine components have caused abrasion or chips.
- Improper maintenance, i.e. the use of poor quality filters and/or oil or the time between inspections is too long.

#### REMEDY/PREVENTION

- Pay great attention to cleanliness when repairing or assembling the engine.
- Only use top quality filters.
- Clean and/or renew the oil mist separator.
- Carry out maintenance at regular intervals according to the manufacturer's specifications.

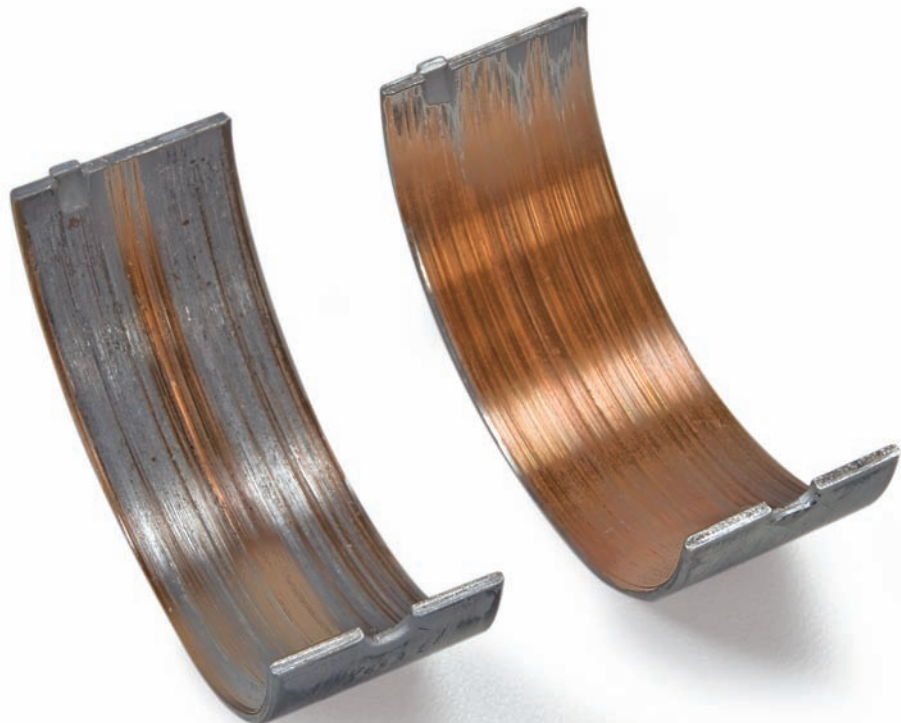

Fig. 1  
Heavy scoring in circumferential direction

## 9.2 Localized wear marks on the running surface of bearings

### DESCRIPTION

- There are localized wear marks on the running surface of the bearing (Fig. 1).
- There may also be imprints on the outer surface of the bearing (Fig. 2).

### PROBABLE CAUSES

- There is contamination or debris wedged between the bearing and the bearing seat.
- The quality of machining is poor, or deburring of the oil holes at the crankshaft is inadequate.

### REMEDY/PREVENTION

- Pay great attention to cleanliness during bearing assembly. Clean the bearings with a leather cloth prior to installation.
- Carefully debur the oil holes after machining the crankshaft pins.



Fig. 1  
Wear marks in the bearing center



Fig. 2  
Contamination imprint on the outer surface of the bearing

## 9.3 Heavy wear marks in the area of the parting line of bearings

### DESCRIPTION

There are heavy wear marks in the area of the parting line of the bearing (Fig. 1a+b).

### PROBABLE CAUSES

The following assembly errors are responsible for this wear:

- The bearing cap is offset (Fig. 2). For example, this can occur when an unsuitable tool with large wrench sockets is used for tightening. It is possible that incorrect adapter sleeves/dowels have been used, the bearing bolts have been tightened with the wrong torque or the bolts have been overstretched.
- The bearing cap has been reversed or improperly fitted; it is also possible that the allocation of caps and cylinders has not been observed.
- The diameter of the holes is too small after re-machining the bearing caps.
- A used connecting rod with an oval 'big end' has been installed without the necessary re-machining of the 'big end' housing being carried out.

### REMEDY/PREVENTION

- Only tighten bolts with a suitable tool.
- Observe the tightening torques of the bearing bolts.
- Pay attention to the allocation of bearing caps and cylinder.
- Check the 'big end' housing and possibly re-machine it.

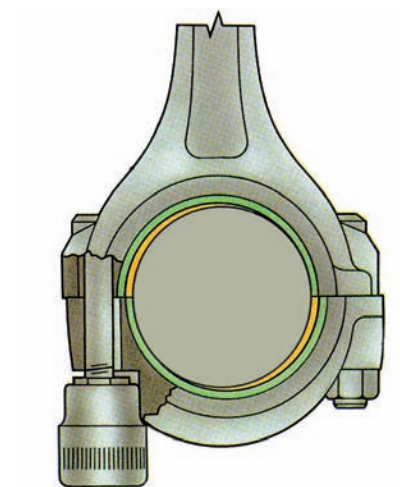

## 9.4 Shiny marks, wear or corrosion on the outer surface of the bearings

### DESCRIPTION

- Shiny marks and/or wear in circumferential direction and/or pitting are visible on the outer surface of the bearing (Fig. 1).

### PROBABLE CAUSES

- Dirt is enclosed in the parting line of the bearing seat, resulting in excessive clearance of the bearings.
- The bearing cap bolts have not been tightened sufficiently.

### REMEDY/PREVENTION

- Pay great attention to cleanliness during bearing assembly. Clean the bearings and the parting line of the bearing seat with a leather cloth prior to installation.
- Check the bolts of the bearing cap according to the manufacturer's specifications and, if necessary, renew them.
- Tighten the bolts of the bearing cap according to the manufacturer's specifications (tightening torque, angle of rotation).



Fig. 1  
Shiny marks on the outer surface of the bearing

## 9.5 Abrasion or damage to the outer edges of the bearings

### DESCRIPTION

The outer edges of the bearing are heavily worn (*Fig. 1–2*).

### PROBABLE CAUSES

This type of damage is caused by a machining defect of the crankshaft. The bearing pins on the crankshaft show an excessive corner radius. The outer edges of the bearings suffer wear on this radius.

### REMEDY/PREVENTION

- Re-machine the bearing pins to the dimension stipulated by the manufacturer.
- Pay attention to the correct position of the bearings during installation.



*Fig. 1*  
Worn outer edges of a bearing

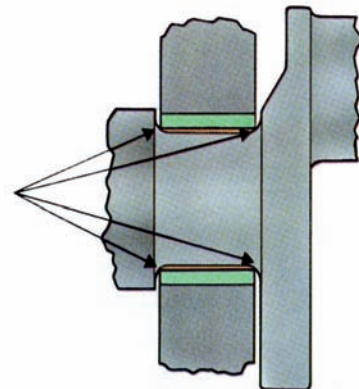

*Fig. 2*  
Excessive radius at the bearing pins



## 9.6 Heavy wear at all main bearings

### DESCRIPTION

All main bearings show clear wear marks (Fig. 1).

### PROBABLE CAUSES

This type of damage is due to a geometrical irregularity caused by either the main bearing line or a bent crankshaft. These geometrical irregularities cause a transmission of force in the bearings which are unable to withstand it. The result is increased wear at all the main bearings. The geometrical irregularities can be caused by the following:

#### Geometrical irregularities in the main bearing line:

- An excessive engine temperature, e.g. due to insufficient coolant, can lead to permanent distortion in the crankcase and thus to distortion in the main bearing line (also see section "4.1 Piston seizure on the thrust and opposite side (piston skirt area only)", page 26).
- Distortion can also be caused by tightening the cylinder head bolts or bearing bolts with the incorrect torque.

#### Bent crankshaft:

- The crankshaft has been aligned incorrectly prior to re-installation.
- Mechanical overload occurred, e.g. piston seizure.
- The torque loading at the crankshaft was too great.

### REMEDY/PREVENTION

- Ensure that the engine is cooled sufficiently (coolant, oil, cooling oil nozzles, thermostat, fan).
- Tighten all the bolts according to the manufacturer's specifications. Pay attention to the specified tightening sequence.
- Align the crankshaft perfectly or replace it prior to installation.

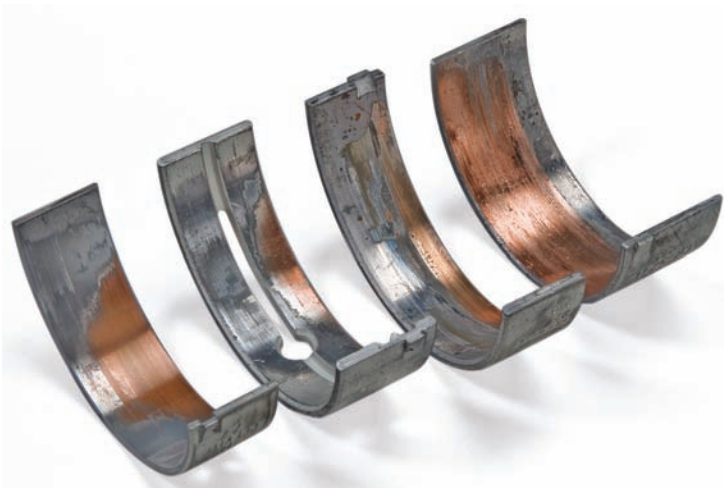

Fig. 1  
Uneven wear at the bearings

## 9.7 Uneven wear pattern at the bearings

### DESCRIPTION

One or several bearings show uneven wear patterns – either only on the edge or only in the center of the bearing (Fig. 1–2).

### PROBABLE CAUSES

This type of damage is caused by geometrical irregularities at the connecting rod and/or the crank pins. These irregularities create high surface pressure either in the center of the bearing or at the outer edges, resulting in an uneven wear pattern at the bearings. This can be attributed to the following:

- The connecting rod is bent due to hydraulic lock (Fig. 3; also see section “2.3 Hydraulic lock”, page 10).
- The connecting rod has not been aligned prior to installation.
- The crankshaft pins have not been re-machined properly, i.e. the surface is either convex, tapered or concave (Fig. 4).

### REMEDY/PREVENTION

- Always check the correct angle of the connecting rods prior to installation and, if necessary, align them.
- Cylindrically grind the crankshaft pins.



Fig. 1  
Uneven wear at the bearings, the bearing layer has been partially removed



Fig. 2  
Uneven wear at the bearings

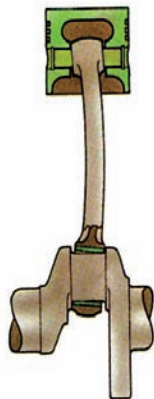

Fig. 3  
Bent connecting rod

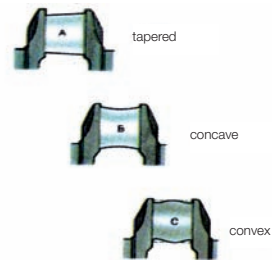

Fig. 4  
Shape deviations at the crankshaft pins

## 9.8 Seizure marks at the bearings



Fig. 1  
Shiny marks on the running surfaces of the bearings



Fig. 2  
Heavily worn and spun bearing

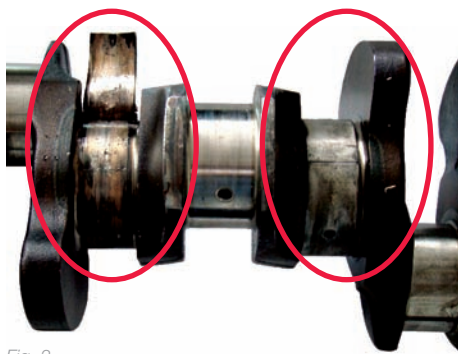

Fig. 3  
Bearing welded to the crankshaft



Fig. 4  
Incorrectly installed bearing – at the outer surface:  
Imprints of the oil feeder holes

### DESCRIPTION

This bearing damage occurs in various stages.

- The first indication is very shiny marks on the bearing (Fig. 1).
- During continuous operation with inadequate lubrication, the bearings first turn blue and then black (Fig. 2).
- In some extreme cases, the lining layer melts (Fig. 3) and the bearing welds to the bearing pin.

### PROBABLE CAUSES

The bearing damage described above is caused by inadequate lubrication. With this type of damage it is important to determine whether just one or all of the bearings are damaged.

#### One bearing is damaged:

- Only one half of the bearing has oil feeder holes. If these bearings are installed with the incorrect orientation, the oil feeder hole (Fig. 4) of the bearing seat is closed and oil cannot reach the bearing.
- Clogged oil feeder holes cause inadequate lubrication. The use of bio-fuels poses a particular risk of oil clouding and thus clogged oil feeder holes.

#### All the bearings are damaged:

- If there is seizure in all of the bearings, there must be a general lack of oil (also see section “2.4 Increased oil consumption”, page 12). There are a numerous reasons for this damage, e.g.:
  - a defective or leaky oil pump or a fault at the pressure limiting valve,
  - a leakage in the oil pipe system,
  - an insufficient level of oil, or
  - an excessive slanting position of the vehicle.

### REMEDY/PREVENTION

- Install the bearings according to the specifications. Pay attention to correct alignment of the oil feeder holes of the bearing and the oil feeder holes in the engine.
- Replace the oil and filter regularly according to the manufacturer's specifications – shorten the change intervals when using biofuels.
- Check the oil level and, if necessary, refill oil.

## 9.9 Pitting on the bearing layer of the bearings

### DESCRIPTION

Pitting is visible on the bearing layer of the bearing. (Fig. 1a+b).

### PROBABLE CAUSES

Pitting is caused by material fatigue of the bearing, resulting from:

- An uneven load: The connecting rod is bent due to hydraulic lock (also see section “2.3 Hydraulic lock”, page 10).
- The connecting rod has not been aligned prior to installation.
- The crankshaft pins have not been re-machined properly, i.e. the surface is either convex, tapered or concave.
- The bearing has been overloaded due to tuning or due to a reduced load-bearing ability of the engine oil. Inadequate load-bearing ability of the engine oil can be caused by using poor quality oil or contamination in the oil, e.g. fuel or coolant (also see section “4.2 Piston seizure on one side of the piston skirt”, page 27).

### REMEDY/PREVENTION

- Only use engine oils approved by the engine manufacturer.
- Always check the correct angle of the connecting rods prior to installation and, if necessary, align them.
- Cylindrically grind the crankshaft pins.



Fig. 1a  
Pitting caused by mechanical overload or inadequate load-bearing ability of the oil film



Fig. 1b  
Close-up view of the damaged bearing layer

## 9.10 Porous bearing layer at the bearings

### DESCRIPTION

The running surface of the bearing shows dark, porous patches (Fig. 1a+b).

### PROBABLE CAUSES

This damage is caused by chemical burns. This can be attributed to the following:

- Chemical substances in the engine oil, e.g. sulphur in poor quality fuel, react aggressively above a certain concentration.
- The engine oil has turned acidic due to gas-fuelled operation (LPG, CNG, etc.).
- The time between oil changes is too long.
- There is coolant residue in the engine oil.

### REMEDY/PREVENTION

- Always carry out the oil change according to the manufacturer's specifications.
- Regularly check the cooling system for leaks or loss of water.

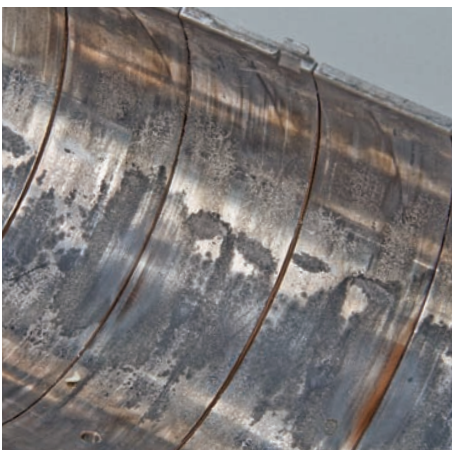

Fig. 1a  
Burned bearing surface due to chemically aggressive substances in the oil



Fig. 1b  
Clearly visible in the close-up view: The corroded bearing material



Fig. 2  
Damaged connecting rod bushing

# 10 Filters

## 10.1 Filter leakage

### DESCRIPTION

There is a sudden loss of liquid or poor performance of the vehicle. Moreover, partial wear is detectable at the engine. Besides the normal leakage at the connection, the following leaks occur:

- Fuel spin-on filter (KC): At the filter housing, there is a longitudinal or transverse crack at the transition radius.
- Inline fuel filter (KL): Either the filter housing is corroded or there is partial corrosion at the line connection due to a damaged fuel hose, resulting in water between the hose and the connecting piece.
- Oil spin-on filter (OC):
  - The filter housing has been cracked (Fig. 1), swollen (Fig. 2) and/or the o-ring housing has been pushed out (Fig. 3) and/or cracked.
  - There is corrosion (Fig. 4).

### PROBABLE CAUSES

#### Fuel spin-on filter (KC):

The cause of the crack at the transition radius is dynamic load (Fig. 1), e.g. if the fuel spin-on filter has been installed incorrectly, it cannot withstand the dynamic pressure load.

If the filter connection is leaky, the following assembly errors may be the cause:

- The filter has been installed in a slanted position (Fig. 5).
- The o-ring is fitted incorrectly.
- An old o-ring has been re-used.
- The tightening torque was incorrect when installing the filter.

#### Inline fuel filter (KL):

- With aluminum housings, contact corrosion between the aluminum and the retaining clamp of the filter can occur due to the protective filter film being removed or damaged (Fig. 6), resulting in the filter being leaky.
- Corrosion or leakage at the line connection can occur due to the following assembly errors:
  - The o-ring is porous, has not been replaced or slipped during assembly.
  - The hoses are not correctly connected to the fittings.
  - The hose clamps are tightened insufficiently.

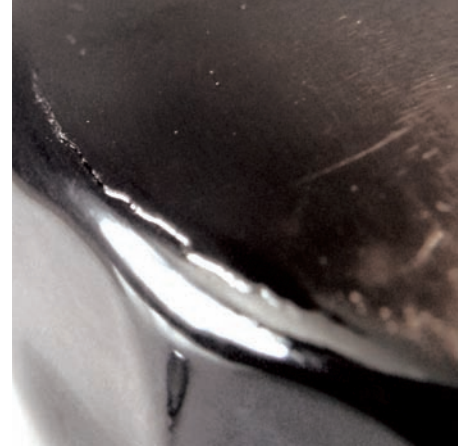

Fig. 1  
Crack in the filter housing due to overload caused by pressure fluctuations



Fig. 2  
For comparison: Swollen filter (left) and new filter (right)

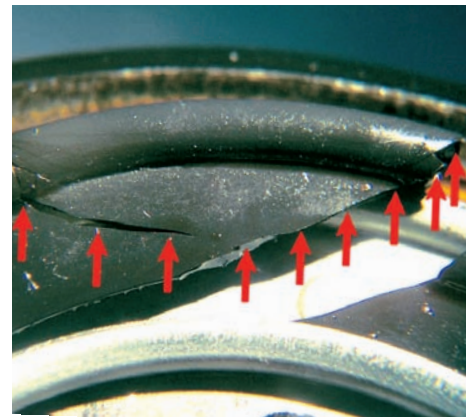

Fig. 3  
Gasket damaged during assembly

**Oil spin-on filter (OC):**

- The filter housing is cracked or swollen or the o-ring has been pressed out or torn due to the following reasons:
  - The pressure limiting valve in the oil pump is defective.
  - An oil filter which has not been approved for the engine has been used (incorrect application).
- The filter has not been tightened correctly.
- Oil filter leakage can be attributed to the following assembly errors:
  - The filter has been installed in a slanted position.
  - The o-ring is fitted incorrectly.
  - The tightening torque was incorrect when installing the filter.
- Corrosion at oil spin-on filters can have the following causes:
  - The time between change intervals is too long.
  - The filter has not been tightened by hand but with a special extraction tool. And the corrosion protection has been damaged.

**REMEDY/PREVENTION**

- Always adhere to the change intervals.
- Only use filters recommended for the engine.
- Do not use a special extraction tool to tighten the filter.
- Always use new seals (o-rings, copper-aluminum washers).
- If considered necessary, it is advisable to replace the pressure limiting valve of the oil pump.
- Always adhere to the assembly instructions.



Fig. 4  
Damaged coating – the result: Corrosion



Fig. 5  
Damaged threads due to an incorrectly installed filter



Fig. 6  
Contact corrosion due to damaged insulation

## 10.2 Reduced engine performance due to the filter

### DESCRIPTION

In spite of normal engine noises, the engine performance has dropped considerably.

### PROBABLE CAUSES

A loss of engine performance can have many reasons. In the area of filtration, there are two major reasons for this damage:

- Insufficient fuel supply due to:
  - the use of an incorrect filter,
  - the intake of additional air,
  - a leaky fuel return pipe
  - a dirty/clogged fuel filter (Fig. 1–2).
- Insufficient air flow rate due to:
  - a dirty air filter (Fig. 3a+b), or
  - a damaged or clogged mass air flow sensor. The damage can be caused by mechanical faults or a defective air filter.

### REMEDY/PREVENTION

- Always use filters approved by the manufacturer.
- Always adhere to the change intervals.
- If necessary, deaerate the system when replacing the fuel filter.
- Check the fuel lines for leaks.
- Change the air filters according to the manufacturer's specifications; or earlier if heavy soiling occurs.
- Carefully clean the sealing surface in the housing when changing the air filter.
- Check correct functioning of the mass air flow sensor.



Fig. 1  
Clogged filter paper – the result:  
Collapsed filter element

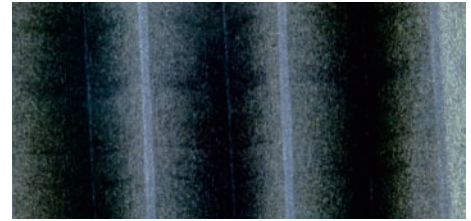

Fig. 2  
Clogged filter paper



Fig. 3a  
Extremely dirty air filter element, filter change imperative



Fig. 3b  
Close-up view



## 10.3 Assembly problems with filters

### DESCRIPTION

The filter can be neither assembled nor disassembled.

### PROBABLE CAUSES

- The spin-on filters have been inserted into the thread connection at an angle, resulting in damage to the thread at the filter and the connection piece.
- The sealing rings of the inline fuel filters are not lubricated.
- Spin-on filters cannot be unscrewed during removal, since the filter has been over-tightened or used for too long.
- The mounting thread at the vehicle is damaged or too short. At many vehicles, the connection piece with the mounting thread is secured via a conternut. If this conternut becomes loose, the length of the thread engagement of the filter changes (Fig. 1–2).

### REMEDY/PREVENTION

- Oil the sealing o-ring of the spin-on filter prior to tightening.
- Prior to assembly, check whether the threaded connection piece has the correct length and whether the conternut is tightened properly.
- Always tighten spin-on filters by hand according to the specifications; never use tools.
- Position the spin-on filter correctly for tightening.
- Always use recommended extraction tools or a ring compressor for removal. Suitable extraction tools: see the filter catalogue.
- Always lubricate the sealing rings for inline fuel filters prior to assembly.

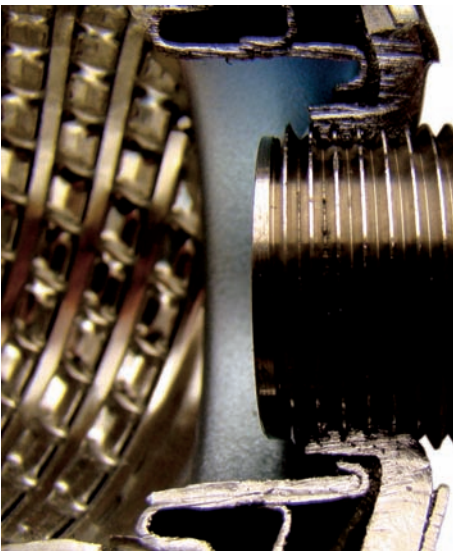

Fig. 1  
Correct thread length

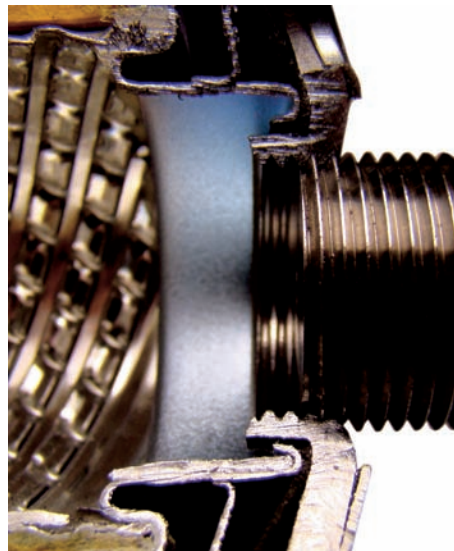

Fig. 2  
Incorrect thread length due to loose conternut

## 10.4 Granules escaping from air dryer cartridges

### DESCRIPTION

When unscrewing the air dryer cartridge, there is partly liquefied and oily granular material in the entire mounting area and in the compressed air lines (Fig. 1–3). There are no granules left in parts of the air dryer.

### PROBABLE CAUSES

The granular material in the air dryer has dissolved and has escaped from the air dryer into the compressed air system. This dissolving of the granules is caused by incorrect usage:

- The time between change intervals is too long.
- Regeneration of the granules is prevented, e.g. by only operating the engine during short journeys.
- The pressure regulator for the regeneration of the drying agent is set incorrectly.
- The granular material has become oily due to a defective or worn air compressor.
- Large pressure losses in the brake system and in the compressed air suspension prevent the compressor reaching the target pressure. In this case, switching to the regeneration phase is not possible.

### REMEDY/PREVENTION

- Always adhere to the stipulated change intervals.
- Avoid short journeys where the ignition is turned off.
- Check the brake and air suspension system for leaks.
- The air dryer requires a regular regeneration phase. To achieve this, set the change-over points correctly at the pressure regulator.



Fig. 1  
Granules escaping from the air dryer cartridge



Fig. 2  
Lumpy granular material



Fig. 3  
Granules, water and oil in the air dryer cartridge

### DESCRIPTION

The filter paper of the liquid filter has become brittle and disintegrated (Fig. 1).

### PROBABLE CAUSES

This type of damage can have various causes. The following factors cause the filter paper of liquid filters to become brittle and disintegrate:

- Chemical substances in the engine oil, e.g. sulphur in poor quality fuel, react aggressively above a certain concentration.
- The temperature level is too high, e.g. tuning the engine or a defective cooling system.
- The time between change intervals is too long.

### REMEDY/PREVENTION

- Always adhere to the change intervals for filters and engine oil. When using biofuels, such as biodiesel or vegetable oil, gas or very sulphurous fuels, shorten the time between change intervals accordingly.
- Regularly check correct functioning of the thermostat, the water pump and the radiator.

Fig. 1  
Disintegrated filter paper of  
an oil filter cartridge

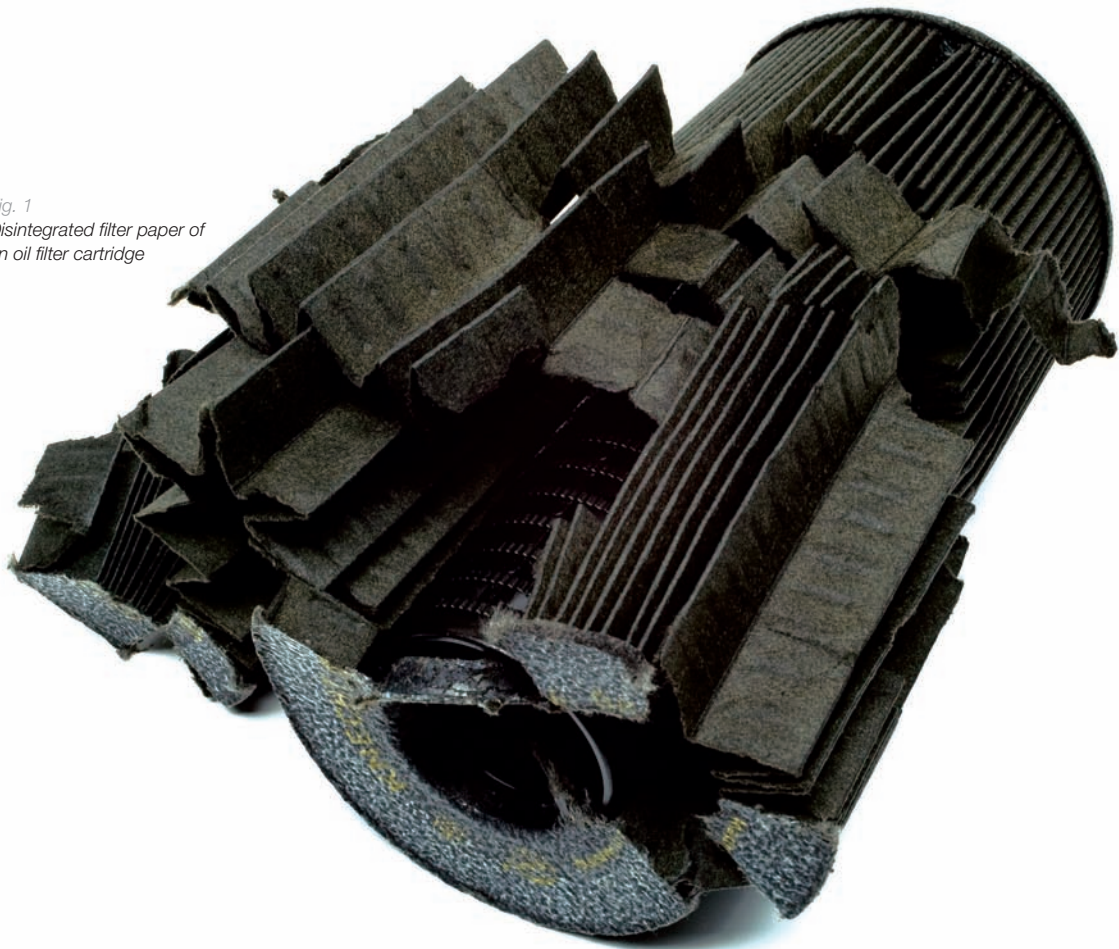

## 11 Glossary

Additional air	Air entering the system at a leakage.
Air compressor	Engine-operated compressor which generates air for compressed air brake systems in commercial vehicles.
Air flow rate	The quantity of air (measuring unit: liter/hour) flowing through a medium (filters or pipes).
Angle of rotation	Angle by which the anti-fatigue bolts are tightened in addition to a specific tightening torque.
Anti-freeze	Coolant additive. It changes the physical properties of the water. Thus preventing the cooling water from freezing and increasing the boiling point. It additionally serves as a lubricant for the bearings and the water pump, as well as corrosion protection in the engine.
Biodiesel	Biodiesel is – unlike common diesel fuel – not produced from crude oil but from vegetable oil or animal fat.
Biofuels	Fuel produced from biomass.
Blow-by gas	Combustion gas which reaches the crank-case via the pistons.
Cetane rating	A measure of the ignition quality of diesel engine fuels. A higher cetane rating indicates greater ignition performance.
Charge-air pressure	Pressure after the compressor (turbo-charger). The air mass fed to the engine rises with increasing charge-air pressure and therefore with a constant air-fuel mixture also the engine torque or engine performance.
Circlip	Clip fixing the piston pin in the pin bore.
Clamp type connecting rod	Rod used for clamping the piston pin in the 'small end' of the connecting rod. Circlips are thus no longer required for fixing the piston pin in the piston, also known as a 'press fit'.

Clouding (engine oil)	The linking of molecule chains which suddenly thickens the engine oil. This can occur when operating diesel engines with vegetable oils if the time between oil changes is not shortened accordingly.
Cold start enrichment	Enrichment of the air-fuel mixture with fuel. Cold engines require a richer air-fuel mixture for optimal concentricity.
Contact alteration of the piston	Changing the piston in the top and bottom dead center from the thrust to the opposite side and vice-versa.
Cooling oil nozzle	Bent tube which ensures that the permissible temperature level is observed by directly injecting the inner piston with engine oil from the oil circuit. For pistons with a cooling channel, the engine oil is injected into the circular channel, thus ensuring improved cooling of the piston.
Dead center	Position of the piston in the cylinder: highest position = top dead center; lowest position = bottom dead center.
End gap	Gap between the ends of a piston ring when installed.
Erosion	Damage on component surfaces due to liquids or hot gases.
Extraction tool	Tool for removing spin-on filters or oil filter caps. Name at MAHLE: OCS. The tool should only be used for removing, not for screwing on filters (risk of damaging the corrosion protection).
Fan	Propeller blowing fresh air at the radiator. The fan is mechanically driven by the engine via a viscous clutch, or via a separate electric motor.
Fatigue fracture	Fracture of a component caused by stress cycles.
Fitting clearance	Dimensional difference between the largest piston diameter and cylinder diameter at 20 °C. A graphite coating at the piston is not considered here.

Fuel delivery	Amount of injected fuel for diesel engines.
Gas-fuelled operation	Combustion engine mainly operated with gas (not petrol, usually autogas, natural gas (LPG, CNG, etc.) or fermentation gases).
Granules	Hygroscopic substance in the air dryer which absorbs water from the air.
Heat value	Index of spark plugs.
Honing	Honing is the final process used in the machining of cylinder bores, either during manufacture or in re-sizing (re-boring). Honing is used to put cross-hatch lines on the cylinder bore which will give good life span, and aid lubrication and oil consumption characteristics in use.
Honing stones	The grinding tool (grinding stones) used to execute the honing process.
Ignition (timing)	Position of the crankshaft at which the air-fuel mixture for gasoline engines is ignited via the spark plug.
Lambda probe	Sensor in the exhaust gas system for analyzing and controlling the exhaust gas concentration.
Load-bearing ability	Stability of the oil film.
Machining profile	Precisely defined rotation profile at the piston skirt for optimizing the tribological conditions.
Mass air flow sensor	Sensor in the air intake system for measuring the intake air, required for setting the optimum air-fuel mixture.
Material fatigue	Damage to the material due to excessive mechanical overload.
Octane rating	The measurement of gasoline's ability to resist engine knocking (tendency to auto ignition). The following applies: If fuel has a high octane rating, it will have a higher resistance to engine knocking.

Opposite side	The side which is less stressed during the power stroke.
Over-speeding	Running the engine above the rated speed. High rpm can, e.g., arise when clutching after shifting to a too low gear.
Overload fracture	Fracture of a component caused by very strong overload.
Piston protrusion/retrusion	This is the distance that the piston travels above/below the cylinder block face when it is at rest at top dead center. Protrusion means that the piston is above the top of the block face. Retrusion means that the piston is below the top of the block face.
Piston seizure	Damage caused by the piston and the cylinder rubbing against each other for too long without lubrication or with excessive contact pressure.
Pitting	A form of localized corrosion that leads to the creation of small holes in the piston material.
Polymerization	The linking of molecule chains which suddenly thickens the engine oil.
Pressure limiting valve (oil pump)	Valve which prevents pressure peaks or general excess pressure in the oil circuit by feeding oil directly back from the oil pump to the oil pan.
Protrusion	Distance between the top of the piston (piston at the top dead center) and the cylinder head.
Regeneration phase	The phase in which water is removed from air dryer granules with a backflow of dry air from the air tank. The regeneration phase is introduced via control valves.
Seizure marks	Damage caused by two moving metal parts rubbing against each other for too long without lubrication or with excessive contact pressure.
Smearred metal layer	Material compression arising during honing due to worn or clogged honing stones; can lead to increased oil consumption.

Spin-on filter	Screw-on filter.
Start of fuel delivery	Start of fuel injection at a specified crank angle before the top dead center of the piston for diesel engines.
Sulphurous fuel	Diesel fuel containing more than 0.5% sulphur. During sulphur combustion, aggressive compounds accumulate in the engine oil and damage components. Therefore, the time between oil changes must be shortened accordingly.
TDC sensor	Sensor for determining the position of the piston in the engine. The data from the sensor is required by the electronic control unit.
Thermostat	Control valve in the coolant circuit. The coolant only circulates in the engine during the warm-up period. The entire coolant flows through the radiator once the engine is warm.
Thrust side	Contact side of the piston during the power stroke.
Tightening torque specifications	Engine manufacturers specify the sequence, the torque and the angle of rotation for tightening anti-fatigue bolts.
Timing	Synchronization between the valve train and the crankshaft position.
Tribological system	Friction and lubrication ratio in the engine.
Tuning	Method for enhancing the engine performance.
Valve keepers	Collet required for fixing valves.
Valve depth	Distance between the tip surface of the cylinder head and the valves.
Viscous clutch	Fan drive for some engine manufacturers. The fan is activated depending on the temperature.









# MAHLE

*Driven by performance*

[www.mahle-aftermarket.com](http://www.mahle-aftermarket.com)

